

A6 Series — Miniature Switches and Pilot Devices: 16mm

Key features of the A6 series switches and pilot lights include:

- 16mm (5/8") mounting hole
- LED illumination
- Compact design saves space
- Momentary, Maintained, Selectors, and E-Stops
- Gold-clad Silver contacts for reliable low level switching
- Snap action contacts
- IP40 (dustproof) or IP65 (oiltight) versions



A2

Switches & Pilot Devices



UL Recognized
File No. E55996



CSA Certified
File No. LR21451



Certificate No.
2030010305027380

Specifications	Degree of Protection	IP40: Dustproof IP65 Waterproof/Oiltight/Corrosion Resistant			
	Contact Configuration	SPDT, DPDT			
	Maximum Voltage	250V AC/DC			
	Thermal Current	3A			
	Minimum Applicable Load	5V AC/DC, 1mA (subject to operating conditions)			
	Contact Material	Gold-clad silver			
	Terminal Style	.110" Solder/ Quick Connect			
	Operating Temperature	LED Type: -25° to +55°C (no freezing)			
	Operating Humidity	45 to 85% RH			
	Contact Resistance	50mΩ maximum (initial value)			
	Insulation Resistance	100MΩ minimum (500V DC megger)			
	Vibration Resistance	10 to 55Hz, amplitude 1.5mm p-p			
	Shock Resistance	Damage limits: 500m/sec ² (approx. 50G) Operating extremes: 200m/sec ² (approx. 20G)			
	Electrical Life	100,000 operations minimum (at full rated load)			
Mechanical Life	Maintained: 100,000 operations minimum Momentary: 1,000,000 operations minimum Selector/Keylock: 250,000 operations minimum				
Dielectric Strength	Switch Unit: 2,000VAC, 1 min. between live/dead part and terminals of different poles; 1,000V AC, 1 minute between terminals of the same pole; 1,500V AC, 1 minute between contact and lamp terminals. Illumination Unit: 2,000VAC, 1 min. between live part/ground				
Soldering Temperature	20W/5 seconds or 260°C/3 seconds				
Contact Ratings	Operating Voltage	24V	120V	240V	
	AC (50/60Hz)	Resistive	—	1.0A	0.5A
		Inductive	—	0.7A	0.5A
	DC	Resistive	1.0A	0.2A	—
Inductive		0.7A	0.1A	—	
LED Lamp Ratings	Rated Voltage/Current	5V DC ±5%	6V AC/DC (±10%)	12V AC/DC (±10%)	24V AC/DC (±10%)
		8mA	DC: A, R, W, Y: 6mA G, S: 5mA AC: A, R, W, Y: 8mA G, S: 7mA	DC: 8mA AC: 9mA	DC: 8mA AC: 9mA







1. AC Inductive Load, PF = 0.6 – 0.7; DC Inductive Load, L/R = 7ms.
2. Minimum applicable load (reference value) is 5V AC/DC/1mA (applicable range is subject to the operating conditions and load).
3. LED lamp contains a built-in current-limiting resistor and a protection diode.
4. LED's don't "burn out." Luminance is reduced to 50% of initial intensity after being lit for 50,000 hours continuously.

A2

Switches & Pilot Devices

AB6 Non-Illuminated Pushbuttons (Assembled)

Part Numbers: Non-Illuminated Pushbuttons

	Style	Contact	Part Number			
			Momentary		Maintained (Latching)	
			Dustproof (IP40)	Oiltight (IP65)	Dustproof (IP40)	Oiltight (IP65)
Standard Button	Round 18mm 	SPDT DPDT	AB6M-M1-① AB6M-M2-①	AB6M-M1P-① AB6M-M2P-①	AB6M-A1-① AB6M-A2-①	AB6M-A1P-① AB6M-A2P-①
	Square 18mm 	SPDT DPDT	AB6Q-M1-① AB6Q-M2-①	AB6Q-M1P-① AB6Q-M2P-①	AB6Q-A1-① AB6Q-A2-①	AB6Q-A1P-① AB6Q-A2P-①
	Rectangular 18mm x 24mm 	SPDT DPDT	AB6H-M1-① AB6H-M2-①	AB6H-M1P-① AB6H-M2P-①	AB6H-A1-① AB6H-A2-①	AB6H-A1P-① AB6H-A2P-①
Oversize Button	Round 23.5mm 	SPDT DPDT	-	AB6M-M1P-M① AB6M-M2P-M①	-	AB6M-A1P-M① AB6M-A2P-M①
	Square 23.5mm 	SPDT DPDT	-	AB6Q-M1P-Q① AB6Q-M2P-Q①	-	AB6Q-A1P-Q① AB6Q-A2P-Q①
	Rectangular 17.5 X 23.5mm 	SPDT DPDT	-	AB6Q-M1P-H① AB6Q-M2P-H①	-	AB6Q-A1P-H① AB6Q-A2P-H①

① Button Color Code

Color	Code
Black	B
Green	G
Red	R
Blue	S
White	W
Yellow	Y

- In place of ①, specify Button Color Code from the table at the right.
- To order as sub-assembled, see page A2-19.
- For accessories, see page A2-25.
- For dimensions, see page A2-27.

Part Numbers: AB6-V Pushlock Turn Reset

Shape	Operation	Contact	Part Number		Remarks
			Dustproof (IP40)	Oiltight (IP65)	
23.5mm Round Mushroom 	Pushlock Turn Reset	SPDT DPDT	AB6M-V1-R AB6M-V2-R	AB6M-V1P-R AB6M-V2P-R	1. Button available in red only. 2. Replacement button: order AB6M-V-R

Part Numbers: Buzzer

Style	Shape	Voltage	Part Number
	Round (18mm)	12V DC	UZ6-11
		24V DC	UZ6-12

AB6 Non-Illuminated Pushbuttons (Sub-Assembled)



Part Numbers: Operators

Style	Contact	Operator	Part Number		
			Round	Square	Rectangular
Non-Illuminated Pushbuttons 	SPDT	Momentary	AB6M-M100	AB6Q-M100	AB6H-M100
		Maintained	AB6M-A100	AB6Q-A100	AB6H-A100
	DPDT	Momentary	AB6M-M200	AB6Q-M200	AB6H-M200
		Maintained	AB6M-A200	AB6Q-A200	AB6H-A200

Part Numbers: Buttons/Lens

Description	Part Number	
	Button	
	Dustproof (IP40)	Oiltight (IP65)
Round 	AB6M-BK1-①	AB6M-BK2-①
Square 	AB6Q-BK1①	AB6Q-BK2-①
Rectangular 	AB6H-BK1-①	AB6H-BK2-①
Round Oversize 	–	AB6M-BK2-M①
Square Oversize 	–	AB6Q-BK2-Q①
Rectangular Oversize 	–	AB6Q-BK2-H①

① Button Color Code

Color	Code
Black	B
Green	G
Red	R
Blue	S
White	W
Yellow	Y









- In place of ①, specify Button Color Code from table on right.
- Buttons which are rated IP65 include a waterproof rubber gasket.
- For accessories, see page A2-25.

AL6 Illuminated Pushbuttons (Assembled)

Part Numbers: LED Illuminated Pushbuttons

A2

Switches & Pilot Devices

Description	Style	Voltage	Contact	Part Numbers			
				Momentary		Maintained (Latching)	
				Dustproof (IP40)	Oiltight (IP65)	Dustproof (IP40)	Oiltight (IP65)
Standard Lens	Round 18mm diameter 	24V AC/DC ±10%	SPDT DPDT	AL6M-M14-② AL6M-M24-②	AL6M-M14P-② AL6M-M24P-②	AL6M-A14-② AL6M-A24-②	AL6M-A14P-② AL6M-A24P-②
	Square 18mm 	24V AC/DC ±10%	SPDT DPDT	AL6Q-M14-② AL6Q-M24-②	AL6Q-M14P-② AL6Q-M24P-②	AL6Q-A14-② AL6Q-A24-②	AL6Q-A14P-② AL6Q-A24P-②
	Rectangular 18mm x 24mm 	24V AC/DC ±10%	SPDT DPDT	AL6H-M14-② AL6H-M24-②	AL6H-M14P-② AL6H-M24P-②	AL6H-A14-② AL6H-A24-②	AL6H-A14P-② AL6H-A24P-②
Oversize Lens	Round 24mm diameter 	24V AC/DC ±10%	SPDT DPDT	-	AL6M-M14P-M② AL6M-M24P-M②	-	AL6M-A14P-M② AL6M-A24P-M②
	Square 24 mm 	24V AC/DC ±10%	SPDT DPDT	-	AL6Q-M14P-Q② AL6Q-M24P-Q②	-	AL6Q-A14P-Q② AL6Q-A24P-Q②
	Rectangular 18mm x 24mm 	24V AC/DC ±10%	SPDT DPDT	-	AL6Q-M14P-H② AL6Q-M24P-H②	-	AL6Q-A14P-H② AL6Q-A24P-H②



- In place of ②, specify Lens/LED Color Code from table below.
- Lamps also available in 5V DC, 6V AC/DC or 12 V AC/DC, change "4" using voltage/lamp codes (ie AL6M-M13-② uses 12V AC/DC LED).
- LED lamp is included in unit and contains a current-limiting resistor and a protection diode. (External resistor not required.)
- To order as sub-assembled, see page A2-21.
- For accessories, see page A2-25.
- For dimensions, see page A2-27.

② Lens/LED Color Code

Color	Code
Amber	A
Green	G
Red	R
Blue	S
White	W
Yellow	Y

Voltage Code

Voltage	Code
5V DC	1
6V AC/DC	2
12V AC/DC	3
24V AC/DC	4



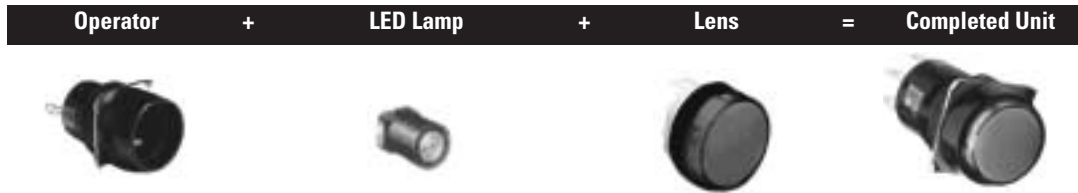



AL6 Illuminated Pushbuttons (Sub-Assembled)



Part Numbers: Operators

Style	Contact	Operator	Part Number		
			Round	Square	Rectangular
AL6 Illuminated Pushbuttons 	SPDT	Momentary	AL6M-M100	AL6Q-M100	AL6H-M100
		Maintained	AL6M-A100	AL6Q-A100	AL6H-A100
	DPDT	Momentary	AL6M-M200	AL6Q-M200	AL6H-M200
		Maintained	AL6M-A200	AL6Q-A200	AL6H-A200

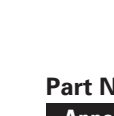
Part Numbers: Lenses

Unit	Part Number		
Degree of Protection	Dustproof (IP40)	Oiltight (IP65)	
Size	Standard	Standard	Oversize
Round	AL6M-LK1-② 	AL6M-LK2-② 	AL6M-LK2-M② 
	AL6Q-LK1-② 	AL6Q-LK2-② 	AL6Q-LK2-Q② 
Square	AL6M-LK1-② 	AL6M-LK2-② 	AL6M-LK2-M② 
	AL6Q-LK1-② 	AL6Q-LK2-② 	AL6Q-LK2-Q② 
Rectangular	AL6M-LK1-② 	AL6M-LK2-② 	AL6M-LK2-M② 
	AL6Q-LK1-② 	AL6Q-LK2-② 	AL6Q-LK2-Q② 



1. In place of ②, specify Lens Color Code from table below.
2. Lenses which are rated IP65 include a waterproof rubber gasket.
3. For accessories, see page A2-25.

②Lens/LED Color Code

Color	Code
Amber	A
Green	G
Red	R
Blue	S
White	W
Yellow	Y

Part Numbers: LED Lamps

Appearance	Rated Voltage	Part Number
	5V DC	LATD-5②
	6V AC/DC	LATD-6②
	12V AC/DC	LATD-1②
	24V AC/DC	LATD-2②





In place of ②, specify LED Color Code from table at left.

AL6 Pilot Lights (Assembled)

Part Numbers: LED Pilot Lights

A2

Switches & Pilot Devices

Description	Voltage	Part Number	
		Dustproof (IP40)	Oiltight (IP65)
Round (18mm Lens) 	24V AC/DC	AL6M-P4-②	AL6M-P4P-②
Square (18mm Lens) 	24V AC/DC	AL6Q-P4-②	AL6Q-P4P-②
Rectangular (18mm x 24mm Lens) 	24V AC/DC	AL6H-P4-②	AL6H-P4P-②

② Lens/LED Color Code

Color	Code
Amber	A
Green	G
Red	R
Blue	S
White	W
Yellow	Y



1. In place of ②, specify LED/Lens Color Code.
2. Lamps also available in 5V DC, 6V AC/DC or 12 V AC/DC, change "4" using voltage codes (ie AL6M-P3-② uses 12V AC/DC lamp).
3. LED Lamp is included and contains built-in current limiting resistor and reverse polarity protection diode. (no external resistor required)
4. To order sub-assembled, see page A2-23.
5. For accessories, see page A2-25.
6. For dimensions, see page A2-27.
7. For one piece pilot lights and/or dome lens pilot lights, see page A5-210.

Voltage Code

Voltage	Code
5V DC	1
6V AC/DC	2
12V AC/DC	3
24V AC/DC	4



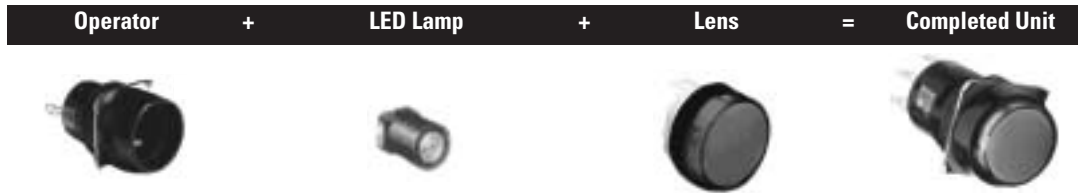



AL6 Pilot Lights (Sub-Assembled)



Part Numbers: Operators

Style	Part Number		
	Round	Square	Rectangular
AL6 Pilot Lights 	AL6M-P00	AL6Q-P00	AL6H-P00

Part Numbers: Lenses

Unit	Pilot Lights	
	Dustproof IP40	Oiltight IP65
Round	AL6M-LK1-② 	AL6M-LK3-② 
	AL6Q-LK1-② 	AL6Q-LK3-② 
Rectangular	AL6H-LK1-② 	AL6H-LK3-② 



- In place of ②, specify Lens Color Code from table below.
- Lenses which are rated IP65 include a waterproof rubber gasket.
- For accessories, see page A2-25.

②Lens/LED Color Code

Color	Code
Amber	A
Green	G
Red	R
Blue	S
White	W
Yellow	Y

Part Numbers: LED Lamps

























Appearance	Rated Voltage	Part Number
	5V DC	LATD-5②
	6V AC/DC	LATD-6②
	12V AC/DC	LATD-1②
	24V AC/DC	LATD-2②







In place of ②, specify LED Color Code from table at left.

AS6 Selector and Keylock Switches (Assembled)

Part Numbers: AS6 Selector Switches and Keylock Switches (2- & 3- Position)

Style	Function	Selector Switches	Keylock Switches	
Round Selector 	2-Position 90°	Maintained 	AS6M-2Y2P	AS6M-2KT2P①
	Spring Return Right 	AS6M-21Y2P	AS6M-21KT2PB	
Round Keylock 	3-Position 45°	Maintained 	AS6M-3Y2P	AS6M-3KT2P①
	Spring Return Right → Center 	AS6M-31Y2P	AS6M-31KT2P①	
	Spring Return Left → Center 	AS6M-32Y2P	AS6M-32KT2P①	
	2-Way Return → Center 	AS6M-33Y2P	AS6M-33KT2PD	
Square Selector 	2-Position 90°	Maintained 	AS6Q-2Y2P	AS6Q-2KT2P①
	Spring Return to Right 	AS6Q-21Y2P	AS6Q-21KT2PB	
	3-Position 45°	Maintained 	AS6Q-3Y2P	AS6Q-3KT2P①
	Spring Return Right → Center 	AS6Q-31Y2P	AS6Q-31KT2P①	
Square Keylock 	3-Position 45°	Spring Return Left → Center 	AS6Q-32Y2P	AS6Q-32KT2P①
	2-Way Return → Center 	AS6Q-33Y2P	AS6Q-33KT2PD	
	Rectangular Selector	2-Position 90°	Maintained 	AS6H-2Y2P
Rectangular Keylock 	2-Position 90°	Spring Return Right 	AS6H-21Y2P	AS6H-21KT2PB
	3-Position 45°	Maintained 	AS6H-3Y2P	AS6H-3KT2P①
Rectangular Keylock 	3-Position 45°	Spring Return Right → Center 	AS6H-31Y2P	AS6H-31KT2P①
	Spring Return Left → Center 	AS6H-32Y2P	AS6H-32KT2P①	
	2-Way Return → Center 	AS6H-33Y2P	AS6H-33KT2PD	

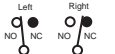
Contact Operations (for all selectors)

Contacts	Operator Position and Contact Operation	
2-pos. (DPDT)	Left	
	Right	
3-pos. (DPDT)	Left	
	Center	
	Right	

Key Retention Codes













Code	Description
A	Key not retained in any position (removable in all positions)
B	Key retained in right position only
C	Key retained in left position only
D	Key retained in left and right (3 position only)
E	Key retained in center only (3 position only)
G	Key retained right and center (3 position only)
H	Key retained left and center (3 position only)



- For more information on these options, contact your IDEC representative.
- Key cannot be removed in a spring return position.

- In place of ①, specify Key Retention Code. See table on right.
- All models are IP65 and DPDT.
- Available as assembled units only.
- For accessories, see page A2-25.
- For dimensions, see page A2-27.

Accessories — A Series: 16mm

Appearance		Description	Used With	Part Number
Locking Ring Wrench		Made of metal. Used for tightening plastic locking ring during installation. Tightening torque should not exceed 3kgf-cm	Ø 5/8" (16mm) units	MT-001
			Ø 31/64" (12mm) AP2M units	MT-002
			Ø 13/32" (10mm) AP1M units	MT-003
Lens Removal Tool		Made of metal. Used for removing lens or button from the housing	All pushbuttons and pilot lights	MT-101
Lamp Holder Tool		Made of rubber. Used for removing and replacing LED lamps in illuminated units	All illuminated pushbuttons and pilot lights	OR-77
Switch Guard		Prevents inadvertent switch operation. IP40 dust-tight rated. 90 degrees opening maintained	Round/Square	AL-K6
			Rectangular	AL-KH6
		Prevents inadvertent switch operation. IP65 oiltight rated 180 degrees opening, spring return	Round/Square	AL-K6SP
			Rectangular	AL-KH6SP
Terminal Cover		Made of translucent nylon. Fits over and shields the terminals	All 5/8" (16mm) units	AL-V6
Dust Cover		Fits over the lens or button to provide protection from dust. (not applicable for oversize lenses or buttons)	All round units	AL-D6
			All square units	AL-DQ6
			All rectangular units	AL-DH6
Adaptor Socket		Plug-on terminal adaptor with solder terminal	All 5/8" (16mm) units	AL-C6
		Plug-on terminal adaptor with PCB terminal		AL-C6V
Mounting Hole Plug		Fills unused panel cutouts. Made of nitrile rubber. Push-in installation from front of panel. IP65 (oiltight) rated.	Rubber	AL-B6
		Fills unused panel cutouts. Made of aluminum. Screw-on locking ring from inside of panel. IP65 (oiltight) rated.	Aluminum	AL-BM6
Replacement LED Lamps		LED with built in current limiting resistor (with all illuminated assemblies).	5V DC	LATD-5②
			6V AC/DC	LATD-6②
			12V AC/DC	LATD-1②
			24V AC/DC	LATD-2②
Replacement Locking Ring		Fastens operators to panel (included with all operators).	All switches & pilot lights	HA9Z-LN
Anti-Rotation Ring		Prevents rotation of switches in panel (included with all operators).	All switches & pilot lights	AL6-LP
Replacement Engraving Inserts		Engraving plates to allow legends underneath translucent lenses (included with all lenses).	Round standard	AL6M-W
			Square standard	AL6Q-W
			Rectangular standard	AL6H-W
			Round oversize	AL6M-MW
			Square/rectangular oversize	AL6Q-QW
Replacement Keys		Pair of keys (#132). All key switches use same standard key.	All key selectors	AS6-SK

A2

Switches & Pilot Devices



- In place of ② specify color code. A=Amber, W=White, G=Green, Y=Yellow, R=Red, S=Blue.
- LEDs include built-in current limiting resistor and reverse polarity protection diode.

Schematics — A Series: 5/8" (16mm)

Switches & Pilot Devices

A2

Terminal Arrangement (Top View)

Illuminated Pushbuttons

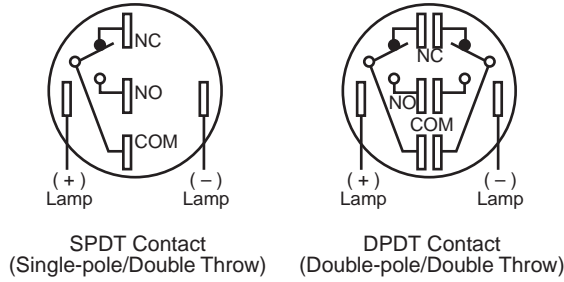

Non-illuminated Pushbuttons and Selector Switches

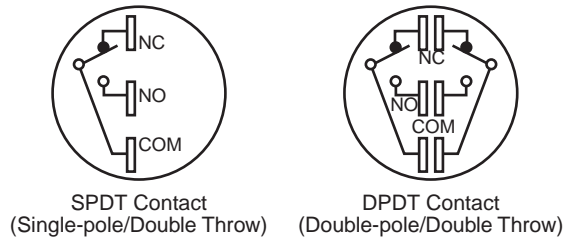

IDEC's Superbright LED

Internal Circuit

LATD-1,-2,-6 (GS)

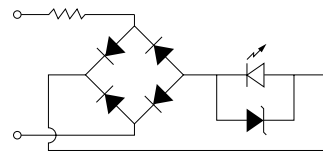

- LED Chip
- Protective Diode
- Zener Diode

LATD-5 (ARWY)



LATD-1,-2,-6 (ARWY)

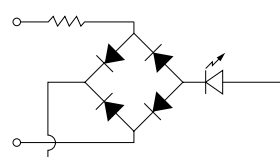

LATD-5 (GS)

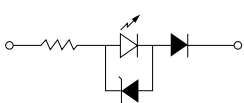

Dimensions — A Series: 5/8" (16mm)

Pushbuttons, Ø 5/8" (16mm)

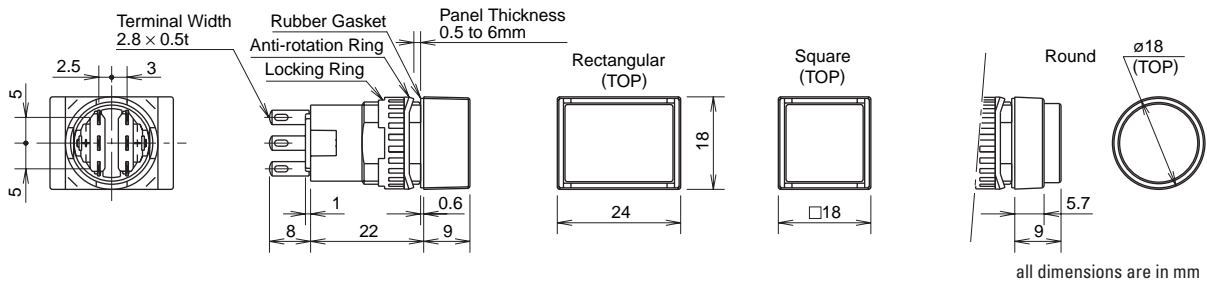

Large Size Lens

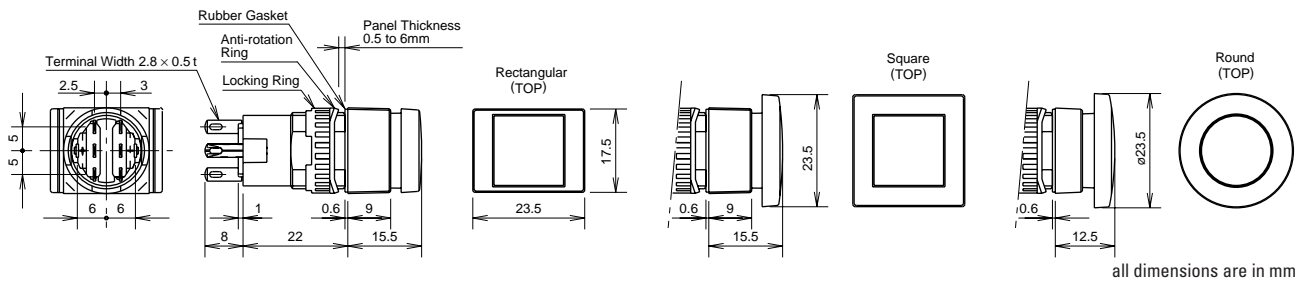

Selector Switches, Ø 5/8" (16mm)

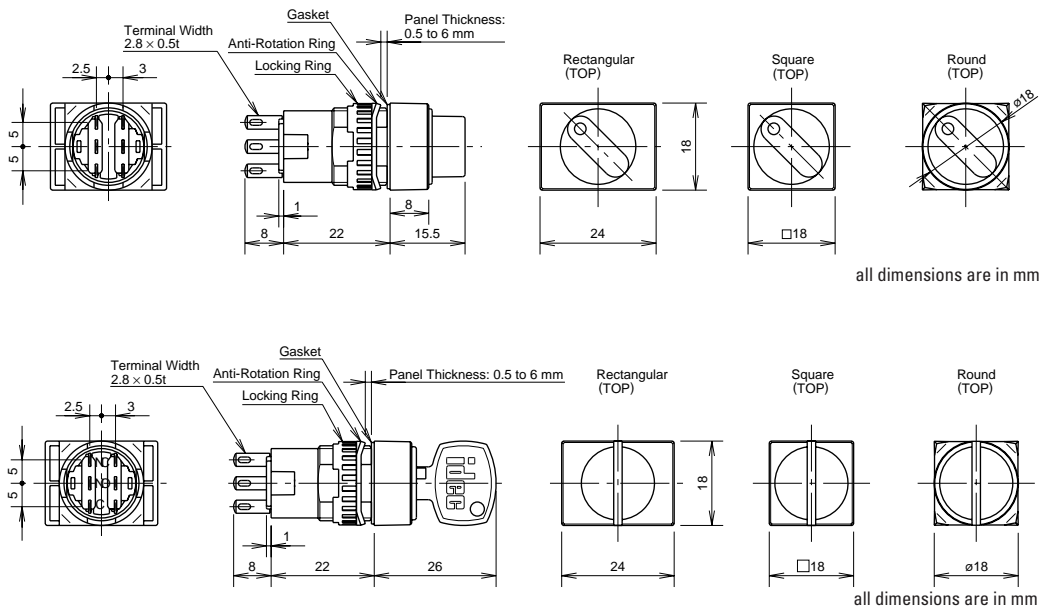

Dimensions con't

Switches & Pilot Devices

A2

Switch Guard, Ø 5/8" (16mm)

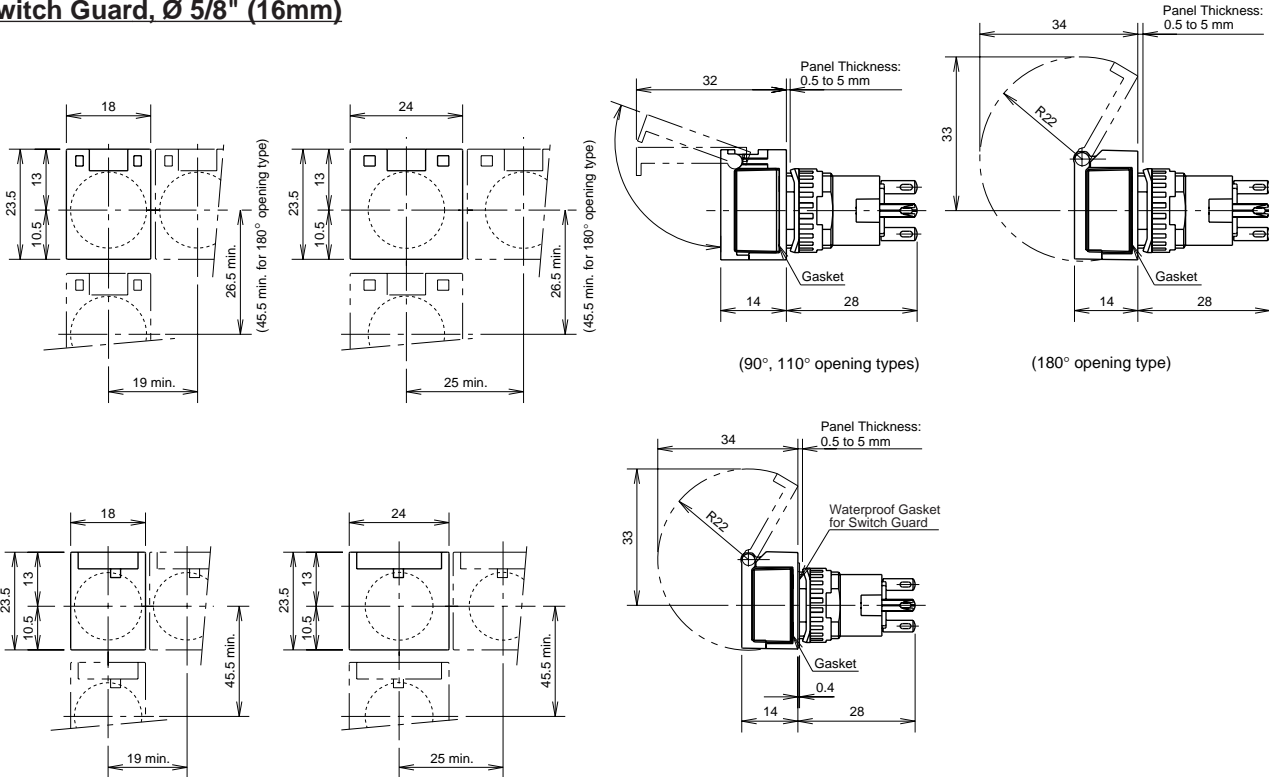

Terminal Sockets

AL-C6, 5/8" (16mm), Solder

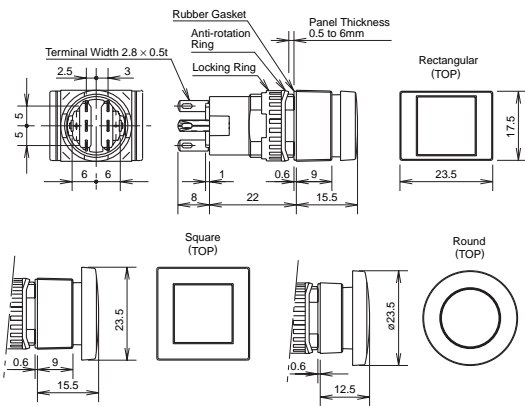

Dust Covers

AL-D6, Round

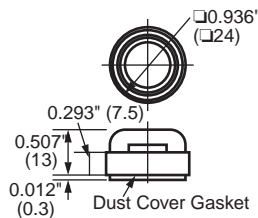

AL-DQ6, Square

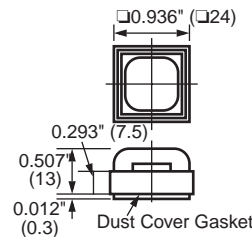

AL-DH6, Rectangular

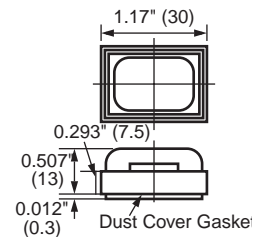

Panel Cut-Outs For Units w/Dust Cover

Round/Square

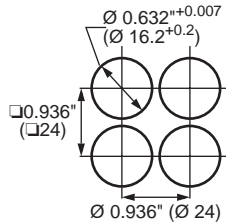

Rectangular

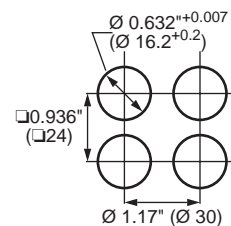

AL-C6V, Ø 5/8" (16mm), PCB

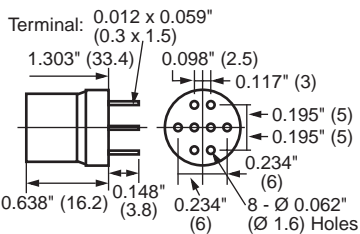

Dimensions con't

Marking Plates for Pushbuttons with Standard Size Lens

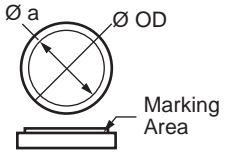
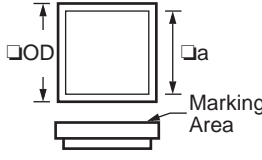
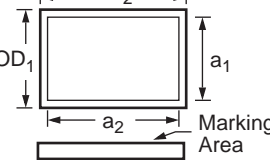
Style	Round—AL6M-W	Square—AL6Q-W	Rectangular—AL6H-W
Dimensions			
Ø 5/8" (16mm)			
Outside (OD)	Ø 0.538" (13.8mm)	□0.538" (13.8mm)	0.538" x 0.772" (13.8 x 19.8mm)
Marking Area (a)	Ø 0.468" (12mm)	□0.468" (12mm)	0.468" x 0.702" (12 x 18mm)



Engraving must be made on the engraving area within 0.02" (0.5mm) deep.

Marking Plates for Pushbutton with Oversize Lens

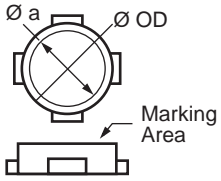
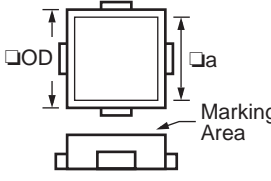
Style	Round—AL6M-MW	Square/Rectangular—AL6Q-QW
Dimensions		
Outside (OD)	Ø 0.491" (12.6mm)	□0.491" (12.6mm)
Marking Area (a)	Ø 0.429" (11mm)	□0.429" (11mm)

Replacing Lens and Marking Plate

Removal

Remove the lens holder assembly (lens, marking plate and holder) from the operator by holding the color lens recesses with the lens removal tool (Part No.MT-101) and pulling out. Remove marking plate by pushing the color lens from the rear to disengage the latches. Marking plate must be engraved on the side as shown in the figure on the right.

Installation

For illuminated and non-illuminated pushbuttons:

1. Insert marking plate inside lens in correct direction.
(For non-illuminated, install marking plate when replacing button).
2. Press color lens on to lens holder to engage latches.
3. Insert lens holder into housing in correct direction.



Do not loosen spring on illuminated pushbutton units (except on pilot light units). The marking plate must be engraved on the front side as shown above.

Ø 5/8" (16mm)

