

SLC30-IPS Series — Panel Mounted Annunciators

The SLC30-IPS combination display lights with control units combine display lights with control units such as pushbuttons, illuminated push-buttons, selector switches, and keylock selector switches.

This results in savings of both space and installation time, since mounting separate switches becomes unnecessary. SLC30-IPS combination display lights can be custom built to meet your specifications.

Key features of the SLC 30 -IPS series include:

- Switches are integrated into an assembled SLC matrix, requiring only one panel cutout
- Illuminated, non-illuminated, selector, and key-switches are available
- Five window sizes based on a 30mm grid
- Non-reflective clear lenses
- Incandescent or Superbright LED illumination
- Momentary pushbuttons only

Display Lights

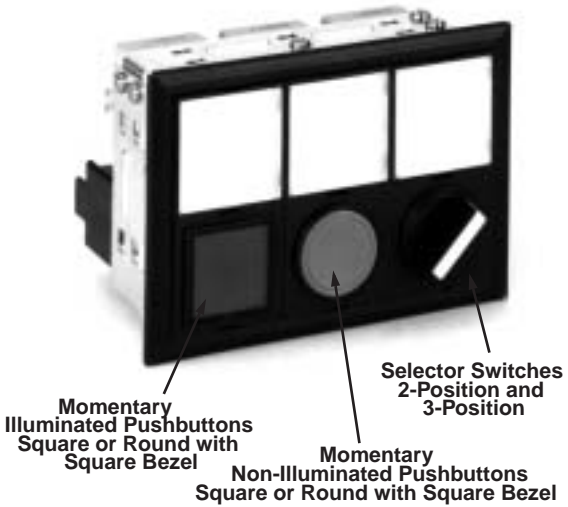

Specifications	Light Source	LED	Incandescent	
	Nominal Voltages	Direct	6, 12, 24V AC/DC	6.3, 18, 24, 30V AC/DC
		Transformer	120, 240V AC	120, 240V AC
		DC-DC Conv.	110V DC	110V DC
Maximum Voltage	250 AC/DC			
Contact Thermal Current	3A (gold contact), 5A (silver contact)			
Contact Operating Current	Gold contact: 125V AC/0.1A, 30V DC/ 0.1A (resistive load) Silver contact: 125V AC/3A, 250V AC/2A (resistive load), 30V DC/2A, 125V DC 0.4AA (resistive load)			
Control Unit Types	Pushbuttons: Square or round, illuminated or non-illuminated (momentary only)			
	Selector switches: 2-position or 3-position, maintained			
	Keylock switches: 2-position or 3-position, maintained			
Colors	Amber, Green, Red, Yellow, Blue, White, dual color Red/Green (24V only)	Amber, Green, Red, Yellow, Blue, White		
Lamp Type	Surface (Chip type) LED cluster (20mA approximately)	BA9S/13 T3-1/4 bayonet base (1W)		
Available Window Sizes				
Insulation Resistance	More than 100 MΩ by a 500V DC megger			
Degree of Protection	IP20 (for indoor use only), NEMA 1			
Dielectric Strength	2,000V AC direct (2,500V AC transformer (1 minute))			
Operating Temperature	- 20° to +40°C; (15-90% relative humidity) (-10° to +40°C DC-DC converter)			
Material of Marking Plate and Color Screen	Polycarbonate			
Termination	M3.5 screw with captive sems plate Check terminals: M3 screw with captive sems plate			
Maximum Size	Full voltage 10 rows, 20 columns (200 windows) Transformer and DC/DC converter 10 rows, 20 columns (50 windows)			
Recommended Wire Size	22-14 AWG x2, (2mm ² x 2)			
Approvals	Cert. No. B970213332375 UL Recognized File No. E69861 CSA Certified File No. LR48366-24			

C Display Lights

Part Numbers (assembled)

Part Number Guide

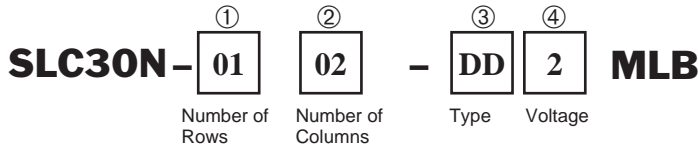

Description			Code	Remark	
① Number of Rows			01, 02, 03, 04, 05, 06, 07, 08, 09, 10	10 row maximum (number of base unit (F style) windows)	
② Number of Columns			01, 02, 03, 04, 05, 06, 07, 08, 09, 10 11, 12, 13, 14, 15, 16, 17, 18, 19, 20	20 column maximum (number of base unit (F style) windows)	
③ Type	LED	Full Voltage	Standard	DD	6V, 12V, 24V
			With check terminal	DHM	24V only
		2 color (Red/Green)	DW	24V only	
	Incandescent	Transformer	TD	120V, 240V AC	
		DC-DC Converter	CD	110V DC only	
			TS	120V, 240V	
④ Voltage	6.3V AC/DC		1	Type DD or DS	
	12V AC/DC		2	With Type DD, DS	
	18V AC/DC		8	Type DS only	
	24V DC		2	Type DD, DW, or DS	
	30V AC/DC		3	Type DS only	
	120V AC		12	Type TD or TS	
	240V AC		24	Type TD or TS	
	110V DC		1	With Type CD	
	No lamp		99	Type DS only	

1. Secondary voltage on transformers and DC-DC converters is 24V.
2. To specify arrangement of varying window sizes and colors, use the order form on the next page.
3. Drawings are required for any units ordered with engraving.

SLC30-IPS Order Form Instructions

How to order a SLC30-IPS display light:

Example 1: Specifying a window color

Enter the lens illumination color code in each square. Use the table below for color codes.

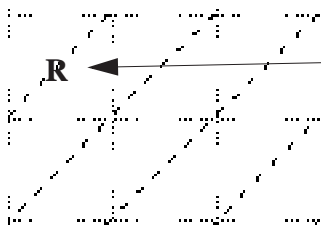

This example would place a Red window in this location.

Color Codes

Color	Code
Amber	A
Green	G
Red	R
Blue	S
White	W
Yellow	Y

Example 2: Specifying a control unit

Enter the control unit code in the lower right half of each square. Use the table above for color codes and the table below for control codes.

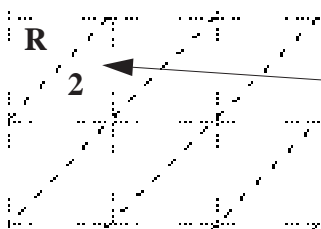

This example would place a Red, square, illuminated pushbutton with silver contacts in this location.

Control Unit Codes

Type	Contact Type	
	Gold	Silver
Square illuminated pushbutton (DPDT)	1	2
Round illuminated pushbutton (DPDT)	3	4
Square pushbutton (DPDT)	5	6
Round pushbutton (DPDT)	7	8
Selector switch (2-position)	9	10
Selector switch (3-position)	11	12
Keylock selector switch (2-position)	13	14
Keylock selector switch (3-position)	15	16

For assistance with developing part numbers or completing the order form on the next page, contact IDEC technical support.

Sheet of

Date _____

Purchase Order No. _____

Fill in Part Number Below:

Contact _____
 Company _____
 Phone # _____
 Ship to _____

SLC30N — — — — —
 Number of Rows Number of Columns Type Code Lamp Voltage

MLB
Black Frame

Note: Convert all window styles to the style F (basic unit size).

Remarks: _____

City/State/ZIP _____

First Window
 (upper, left-hand
 corner of panel)

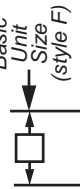

COLUMNS ←

→ **ROWS**

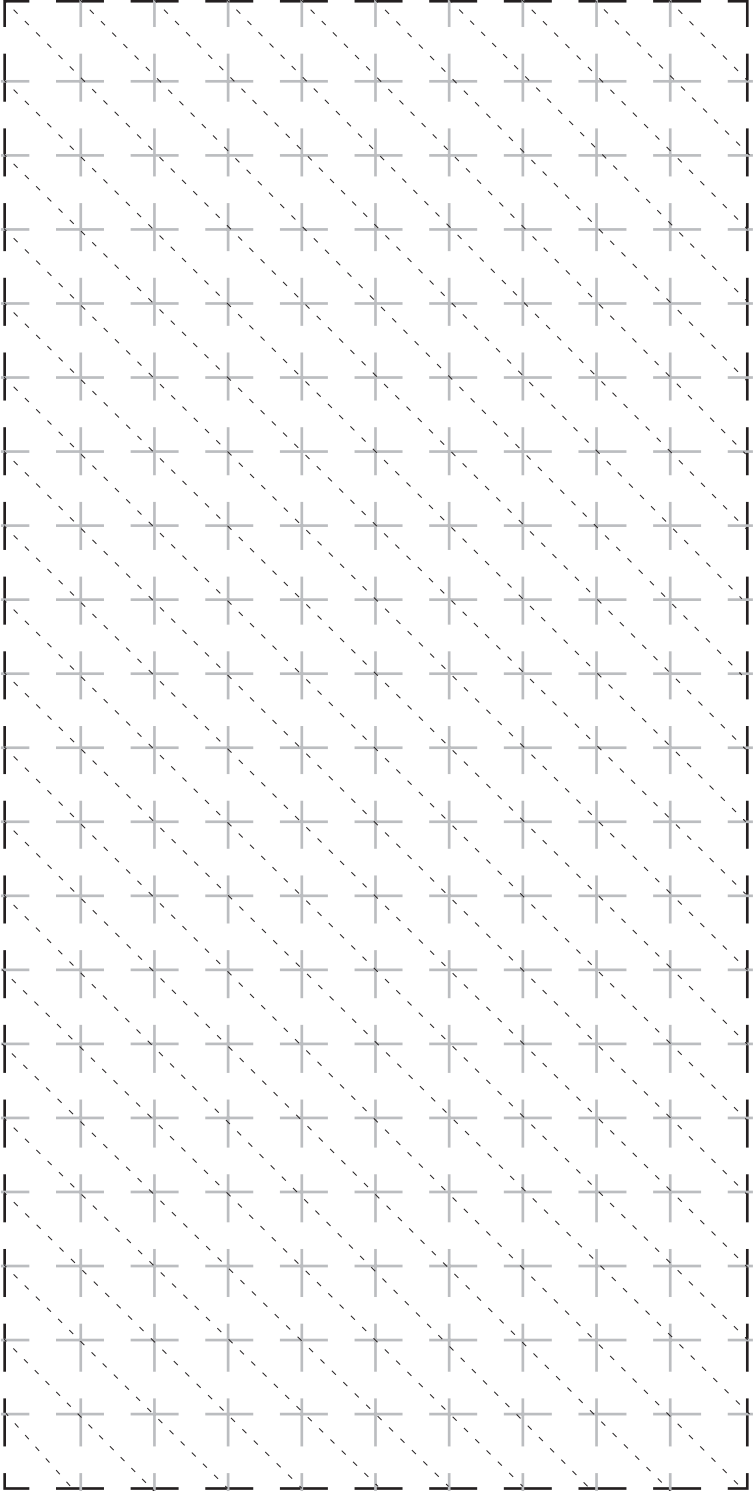

Quantity
 Note: All units ordered on one order form must be identical.

Order Form

↑ **THIS SIDE UP**





↑ **THIS SIDE UP**

1. For SLC30-IPS ordering form instruction, see previous page.
2. See engraving information on the next page.
3. See panel cutout dimensions on page B-27.
4. Additional ordering information is on page B-40.



Engraving Information

Part Numbers: Engraving Plates

Window Type	Part No.	Character Size	Maximum Characters per Line	Maximum Lines
F  30x30mm	SLC-3PF	7/32	7	3
		3/16	7	3
		5/32	9	4
		9/64	9	4
		1/8	10	4
H  30x60mm	SLC-3PH	5/16	8	2
		7/32	13	3
		5/32	17	4
L  30x90mm	SLC-3PL	5/16	14	2
		7/32	20	3
		5/32	26	4
V  60x30mm	SLC-3PV	5/16	4	4
		7/32	6	6
		5/32	8	8
G  60x60mm	SLC-3PG	5/16	9	4
		7/32	12	6
		5/32	16	8

Engraving Size Samples

5/16" size

7/32" size

3/16" size

5/32" size

9/64" size

1/8" size

Display Lights

 *Engraving plates are supplied with all assembled SLC units.*

Engraving Templates

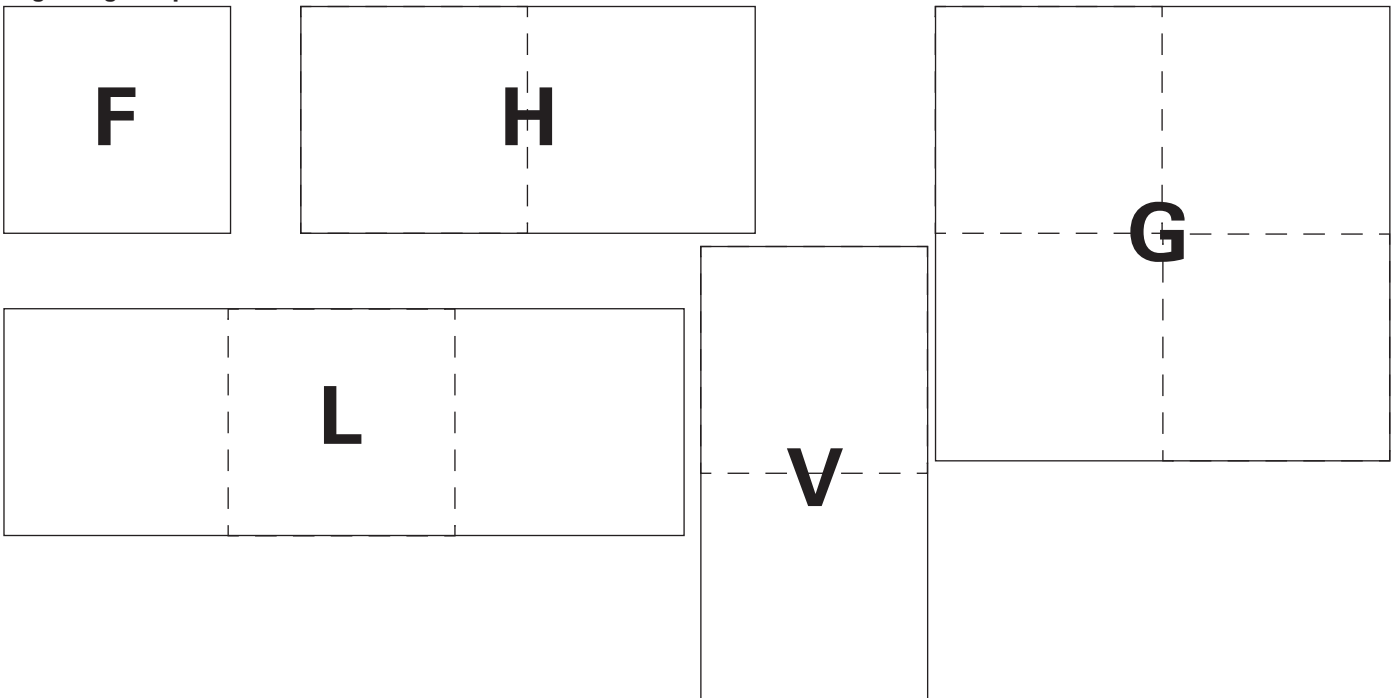

Dimensions

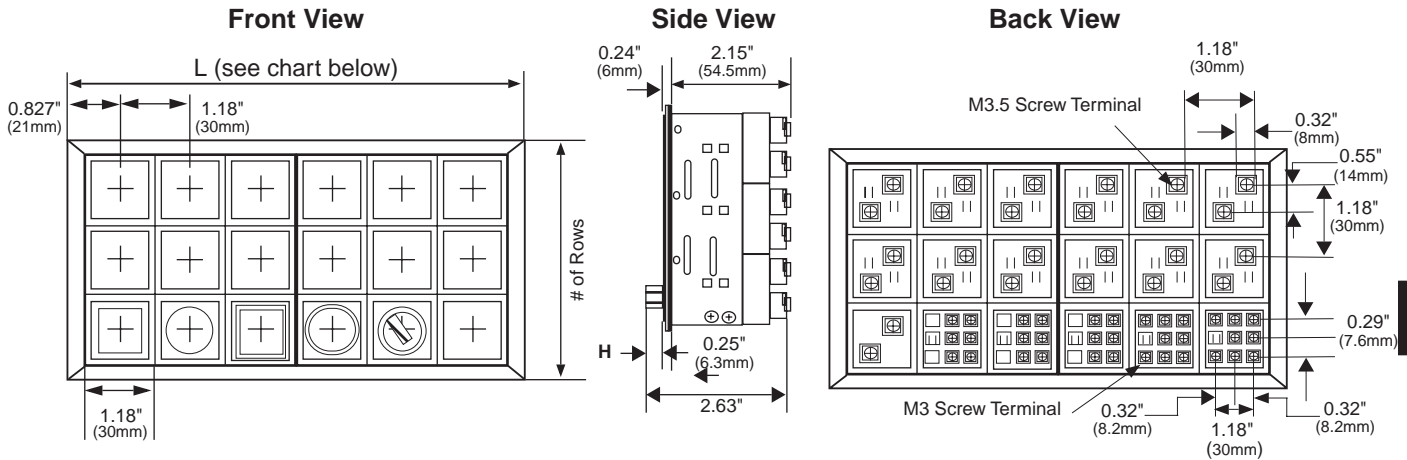

Bottom View

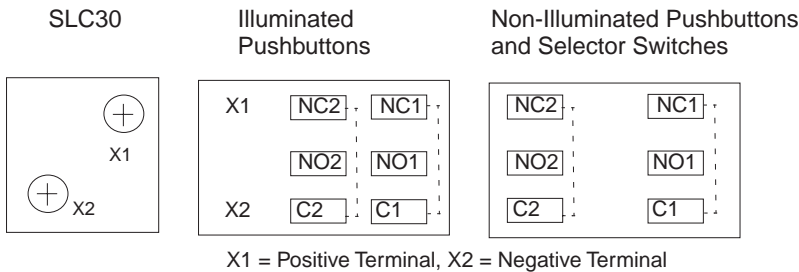

Panel Cut-Out Size

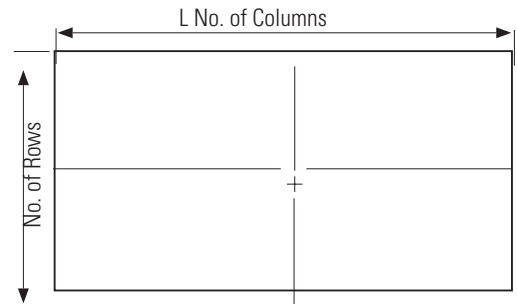

Panel Cut-Out Dimensions

No. of Rows	No. of Columns →																					
	Overall Panel Width Dimension →		1	2	3	4	5	6	7	8	9	10	11	12	13	14	15	16	17	18	19	20
	Overall Height ↓	Cut-out Ht ↓	1	2	3	4	5	6	7	8	9	10	11	12	13	14	15	16	17	18	19	20
1	1.654" (42mm)	1.378" (35mm)	1.378" (35mm)	2.559" (65mm)	3.740" (95mm)	4.921" (125mm)	6.102" (155mm)	7.283" (185mm)	8.465" (215mm)	9.646" (245mm)	10.827" (275mm)	12.008" (305mm)	13.189" (335mm)	14.370" (365mm)	15.551" (395mm)	16.732" (425mm)	17.913" (455mm)	19.094" (485mm)	20.276" (515mm)	21.457" (545mm)	22.638" (575mm)	23.819" (605mm)
2	2.835" (72mm)	2.559" (65mm)	2	4	6	8	10	12	14	16	18	20	22	24	26	28	30	32	34	36	38	40
3	4.016" (102mm)	3.740" (95mm)	3	6	9	12	15	18	21	24	27	30	33	36	39	42	45	48	51	54	57	60
4	5.197" (132mm)	4.921" (125mm)	4	8	12	16	20	24	28	32	36	40	44	48	52	56	60	64	68	72	76	80
5	6.378" (162mm)	6.102" (155mm)	5	10	15	20	25	30	35	40	45	50	55	60	65	70	75	80	85	90	95	100
6	7.559" (192mm)	7.283" (185mm)	6	12	18	24	30	36	42	48	54	60	66	72	78	84	90	96	102	108	114	120
7	8.740" (222mm)	8.465" (215mm)	7	14	21	28	35	42	49	56	63	70	77	84	91	98	105	112	119	126	133	140
8	9.921" (252mm)	9.646" (245mm)	8	16	24	32	40	48	56	64	72	80	88	96	104	112	120	128	136	144	152	160
9	11.102" (282mm)	10.827" (275mm)	9	18	27	36	45	54	63	72	81	90	99	108	117	126	135	144	153	162	171	180
10	12.283" (312mm)	12.008" (305mm)	10	20	30	40	50	60	70	80	90	100	110	120	130	140	150	160	170	180	190	200

Total Number of Windows (equivalent to style F—basic unit size)

Dimensions, continued

JUMPERS

Thickness = 0.020" (0.5mm)

Centers:
SLC30 = 1.181" (30mm)
SLC40 = 1.575" (40mm)

± 0.004" (0.1mm)

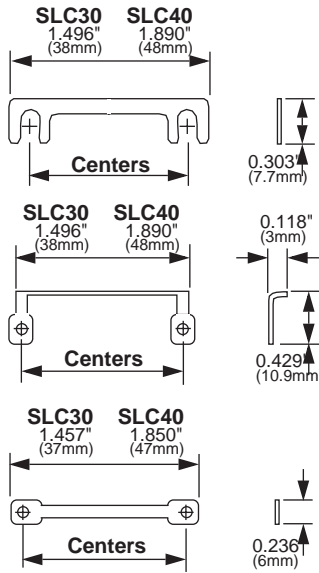

Display Lights

Contact Operations



Selector Switches and Keylock Selector Switches

		Operator Position and Contact Operation (top view)			
	Position	Contacts	Left	Center	Right
Contact Operation	90° 2-position maintained 45°	DPDT 2-position	Left 	—	Right
	 3-position maintained	DPDT 3-position	Left 	Left 	Right



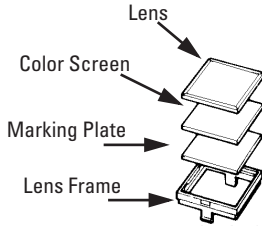

SLC Series Accessories





Description	Application	Part No.	Remarks		
Lenses	SLC30 incandescent, LED	F	SLC-3LF-(UL)	A lens is included with each window on assembled units	
		H and V	SLC-3LH-(UL)		
		L	SLC-3LL-(UL)		
		G	SLC-3LG-(UL)		
	SLC40 incandescent, LED	F	SLC-4LF-(UL)		
		H and V	SLC-4LH-(UL)		
Color Screens	SLC30 incandescent	F	SLC-3PF*-(UL)	Specify color code in place of asterisk (*): A = Amber C = Transparent G = Green (incandescent) R = Red S = Blue W = White Y = Yellow	A color screen and marking plate are included with each window of assembled incandescent units
		H and V	SLC-3PH*-(UL)		
		L	SLC-3PL*-(UL)		
	SLC40 incandescent	G	SLC-3PG*-(UL)		
		F	SLC-4PF*-(UL)		
		H and V	SLC-4PH*-(UL)		
Marking Plates	SLC30 incandescent, LED	F	SLC-3PF-■-(UL)	Specify color code in place of square (■): C = Transparent (LED) W = White (incandescent) WL = White (LED)	Two marking plates are included with each window of assembled LED units; LED units do not use color screens
		H and V	SLC-3PH-■-(UL)		
		L	SLC-3PL-■-(UL)		
		G	SLC-3PG-■-(UL)		
	SLC40 incandescent, LED	F	SLC-4PF-■-(UL)		
		H and V	SLC-4PH-■-(UL)		
Lens Frames	SLC30 incandescent only	F	SLC-3WF-B	A lens frame is included with each window on assembled units	
		H	SLC-3WH-B		
		V	SLC-3WV-B		
		L	SLC-3WL-B		
		G	SLC-3WG-B		
	SLC30 LED only	F	SLC-3WF-BL		
		H	SLC-3WH-BL		
		V	SLC-3WV-BL		
		L	SLC-3WL-BL		
		G	SLC-3WG-BL		
	SLC40 incandescent only	F	SLC-4WF-B		
		H	SLC-4WH-B		
		V	SLC-4WV-B		
	SLC40 LED only	F	SLC-4WF-BL		
		H	SLC-4WH-BL		



Description		Application		Part No.	Remarks
Incandescent Lamps	BA9S/13 (1W) 	SLC30 incandescent only	BA9S/13 lamp base	IS-6	6.3V, 1W; operating voltage: 5 to 6V AC/DC
				IS-12	12V, 1W; operating voltage: 9 to 12V AC/DC
				IS-24	24V, 1W; operating voltage: 18 to 24V AC/DC
				IS-30	30V, 1W; operating voltage: 24 to 30V AC /DC
	E12/15 (2W) 	SLC40 incandescent only	E12/15 lamp base	LE-6	6.3V, 2W; operating voltage: 5 to 6V AC/DC
				LE-8	18V, 2W; operating voltage: 12 to 18V AC/DC
				LE-2	24V, 2W; operating voltage: 18 to 24V AC/DC
				LE-3	30V, 2W; operating voltage: 24 to 30V AC/DC
LED Lamps		SLC30 LED only 1-color	6V AC/DC	SLC-6SP*	Specify color code in place of asterisk (*): A = Amber G = Green R = Red S = Blue (available in 24V version only) W = White Y = Yellow
			12V AC/DC	SLC-1SP*	
			24V AC/DC	SLC-2SP*	
		SLC30 LED only 2-color: Red/Green	24V AC/DC	SLC-2SP-R/G	
			SLC40 LED only 1-color	6V AC/DC	
		12V AC/DC		SLC-1EP*	
		24V AC/DC		SLC-2EP*	
		SLC40 LED only 2-color: Red/Green	24V AC/DC	SLC-2EP-R/G	

Replacement Parts

Full Voltage Models		Description	Type	Part Number
SLC30 	LED	Incandescent	DS	SLC-3DS
		Standard LED	DD	SLC-3DH
		LED w/ Check Terminal	DHM	SLD-3DHM
		Dual Color LED	DW	SLD-3DW
SLC 40 	Incandescent	Incandescent	DE	SLC-4DE
		Incandescent w/ Check Terminal	DEM	SLC-4DEM
		Standard LED	DD	SLC-4DH
		LED w/ Check Terminal	DHM	SLC-4DHM
		Dual Color LED	DW	SLC-4DHW
Step Down Models		Description	Type	Part Number
SLC30 	Incandescent	Incandescent xfrmr, 120V AC	TS12	SLC-3TS120
		Incandescent xfrmr, 240V AC	TS24	SLC-3TS240
	LED	LED xfrmr, 120V AC	TD12	SLC-3TP120
		LED xfrmr, 240V AC	TD24	SLC-3TP240
SLC40 	Incandescent	Incandescent xfrmr, 120V AC	TE12	SLC-4TE12
		Incandescent xfrmr, 240V AC	TE24	SLC-4TE240
	LED	LED xfrmr, 120V AC	TD12	SLC-4TP120
		LED xfrmr, 240V AC	TD24	SLC-4TP240
		LED DC-DC converter, 110V DC	CD1	SLC-4CP1

Description	Application	Part No.	Remarks	
Lamp Holder Tool	SLC30 and SLC40 incandescent	OR-55	Rubber tool eases the removal of incandescent lamps	
Tab Terminal Adaptors 	Used for wiring quick-connect terminals	TW-FA1	#250 tab terminal (W x H): 0.250" x 0.031" (6.35 x 0.8mm) single tab	
Jumpers 	SLC30	X1 terminal (spade)	SLC-JP30	Total number of jumpers equals total number of style F window equivalents
		X2 terminal (ring)	SLC-JP33	
		C terminal (ring)	SLC-JP32	
	SLC40	X1 terminal (spade)	SLC-JP40	
		X2 terminal (ring)	SLC-JP41	
Mounting Clip 	All SLCs	SLC-3K1	Mounting clips are included with the panel (see page C-43 for details about quantity and placement).	
Marking Strip		BNM2	White glossy paper with adhesive back (the dimensions are given below); the marking strip can be stuck to the terminal transformer or directly to the units for identification of the unit or circuit number; Sticker dimension (W x L): 0.197" x 393.701" (5 x 10,000mm)	
Finger-Safe Terminal Covers 	Use with SLC30 types DD, TD, CD, DS and TS	SLC30-VL3		
	Use with all SLC30 types DHM and DW	SLC30-VL6		
	Use with SLC40 types DD, TD, CD, DE and TE	HW-VL3		
	Use with SLC40 types DHM, DW, and DEM	SLC40-VL6		

C
Display Lights

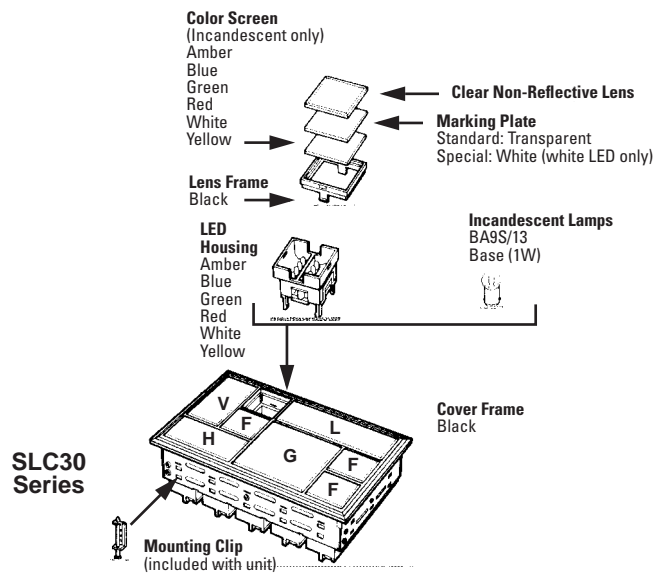

General Information: Ordering SLC Display Lights

When ordering a custom-built combination of SLC display lights for a multiple panel, copy the order form provided. This is the only order form accepted.

Using the Order Form

Part No.: Enter the part number using the part numbering guides.

Quantity: Enter the number of **identical** completely assembled panels required.

Window Count: Convert all window styles to style F (basic unit size) equivalents:

- Style F** = 1 window
- Style H** = 2 windows
(1 row high x 2 columns wide)
- Style L** = 3 windows
(1 row high x 3 columns wide)
- Style V** = 2 windows
(2 rows high x 1 column wide)
- *Style G** = 4 windows
(2 rows high x 2 columns wide)

1. *Style G is available for the SLC30 series only.*



Maximum Windows for Multiple Combination Panels

For style code "M," it is necessary to use the order form. Do not exceed maximum panel sizes:

SLC30: 200 windows (full voltage)
50 windows (other type codes)

SLC40: 105 windows (full voltage)
50 windows (other type codes)

Series: SLC30 1.181" (30mm) or SLC40 1.575" (40mm)

Window style(s): Style F, H, L, or V for SLC30 or SLC40
Style G for SLC30 only
Style M for a multiple combination panel

Row count: Convert all windows to style F (basic unit size) using information in the left column of this page.

Column count: Convert windows to style F (basic unit size) using information in the left column of this page.

Illumination type: LED or incandescent.

Input mode: Full voltage, transformer, or DC-DC conversion for LED; full voltage or transformer for incandescent.

Operating voltage: See preceding page to select voltages compatible with the input mode required.

Window colors: Specify the number of windows in each color.

Engraving: Clearly mark the engravings for each window desired on the grid of the order form clearly. If there is not enough space, number each window and use a separate sheet to write the engravings for each window number. Also note "no engraving."

Using the grid on the order form (following page), show the actual size and placement of all desired windows.



To Specify a Multiple Combination

- Draw a **heavy** outline on corresponding gray lines to show the overall panel size.
- Darken the appropriate gray lines to show the outlines of the various window style(s) required.
- For each window, specify color and clearly identify the engraving desired.



2. *If there is not enough space on the grid to show the engraving clearly, number every required window, and write the engraving on a separate sheet of paper. Make sure to write the window number which corresponds to the engraving, and also make sure to note "no engraving" as required.*

Determining SLC Pricing

1. The initial, 2-window price is determined based on series, type, and style. This 2-window price includes framing and assembly. When ordering a single window, the 2-window price is also the minimum price, including window, framing, and assembly.
 2. Convert all window styles required into style F (basic unit size) equivalents using the information in the left column of this page.
 3. Subtract "2" from the total number of style F equivalent windows determined in step 2. The result is the number of additional windows.
 4. Multiply the number of additional windows determined in step 3 by the additional window price.
 5. Determine the quantity of windows with engravings. Do not use the style F equivalents; use the actual window style(s) required.
3. *The pricing referred to above can be obtained from any authorized IDEC representative or distributor.*
4. *When determining window pricing, **always** convert every window size required to the style F equivalent (basic unit size).*



SLC Series Installation Instructions

Installation Notes

1. Since lamps generate heat, it is recommended that ventilation be provided for cooling when more than ten lamps are lit continuously.
2. A lower number of windows is specified for multiple transformer, AC adaptor, and DC-DC converter units (50 maximum, instead of 200 as for full voltage only). This is done to avoid damage which may result from excessive heat generation when all lamps are lit simultaneously.
3. When multiple units are panel mounted, determine panel thickness so that the combined weight of all units and connecting wires can be supported.
4. Multiple units are not designed for continuous, simultaneous lighting of all lamps. However, it is possible to conduct a lamp test with all lamps lit simultaneously for a period of up to 40 minutes.
5. Before removing the LED unit, turn the power supply off.
6. DC-rated voltages for LED units are complete direct current voltages. Make sure to check the measuring instruments and compensate for any error in the measured, full-wave rectified or pulsating voltages.
7. To ensure brightness and long life of LED units, keep the DC power voltage within the operating voltage range.

LED Operating Voltage Range: 24V DC \pm 10%

Terminal Arrangements (LED units)

For full voltage (1- and 2-color) and DC-DC converter LED units, terminal X1 is positive and terminal X2 is negative. Make sure to observe polarity when wiring.

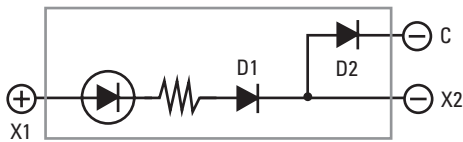

For 2-color alternate units, terminal X1 is positive, and terminals X2 and C (check terminal) are negative.

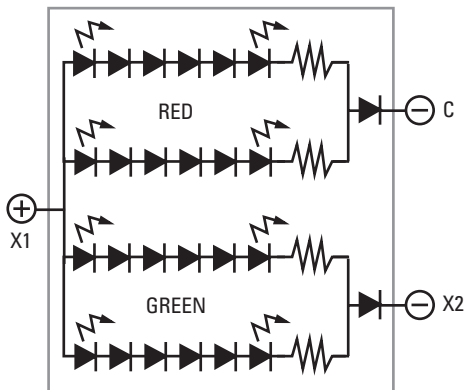
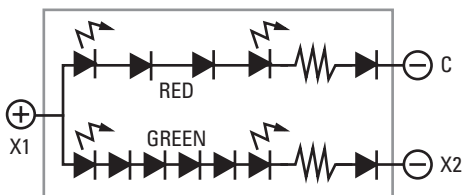

SLC30 Full Voltage DC-DC Converter

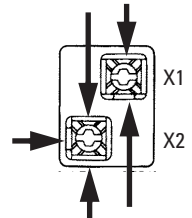

SLC30 AC Adaptor Transformer

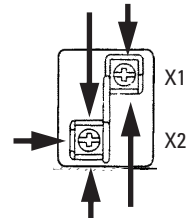

SLC40 Full Voltage DC-DC Converter

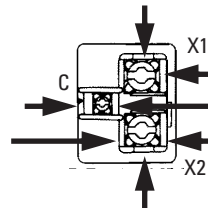

SLC30/40 2-Color LED (alternating)

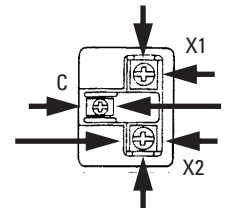

SLC30



SLC40



Installation Instructions, continued

Removing Windows

SLC30: To remove a window, insert the tip of a small screwdriver into the slot under the lens frame and gently press down on the screwdriver.

SLC40: To remove an extended window, pull on the top as if to extend the unit; then continue pulling until the unit comes out of the housing. All units are shipped with windows retracted. When transporting units, make sure windows are pushed in fully. After windows are installed, they can be extended as shown in *Figure 1*.



Figure 1: SLC40



Figure 2: SLC30 and SLC40

Removing Lens, Color Screen, and Marking Plate

The lens has two retaining projections on the right and two on the left. To remove the lens, color screen, and marking plate from the lens frame, push open the lens frame with both hands as shown in *Figure 2*.

The lens can also be removed by inserting a screwdriver into one of the sides with recesses. Since the lens has an orientation, be sure to insert the screwdriver in the direction shown in *Figures 3 and 4*.



Figure 3: SLC30



Figure 4: SLC40

Installing Lens, Color Screen, and Marking Plate

First, install the marking plate and color screen into the lens frame. To install the lens, insert its retaining projections into the recesses inside the lens frame, and press the lens into the lens frame as shown in *Figure 5*.

Replacing the LED Unit

To remove: Insert the tip of a screwdriver into one of the two slots inside the LED unit. Pull the LED unit straight out without pressing on the LED terminals, as shown in *Figure 6*.

To install: Make sure that the junction inside the LED unit is aligned in the same direction as the junction of the LED housing. Push the LED unit into the LED housing as shown in *Figure 7*.

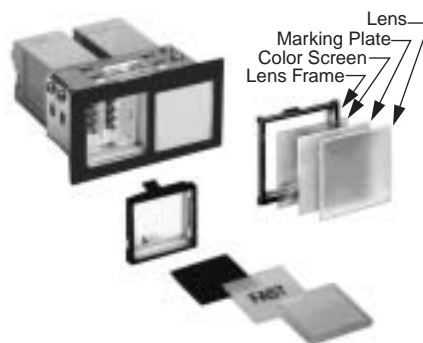

Figure 5: SLC30 and SLC40

Installing Units into a Panel

Single units: With leaf springs installed, push the SLC housing from the front of the panel. Secure the SLC housing with two mounting clips. Tighten the mounting clip screws to a torque of 4 to 5 kgf-cm as shown in *Figure 8*.

Multiple combination units: Insert the units into the panel cut-out from the front. Install the attached mounting clips into the openings on the frame, and tighten the screws as shown in *Figure 9*. After tightening, use Loctite to prevent loosening. The number of mounting clips included with each multiple unit varies with the number of windows as shown in the table below.



Figure 6: Remove LED



Figure 7: Install LED



Figure 8: Single Unit



Figure 9: Multiple Combination

SLC Series Installation Instructions, continued

Number of Mounting Clips Included

Columns	1 or 2		3 to 8		9 to 15	16 to 20 *
Rows	Full Voltage	Others	Full Voltage	Others	All Types	All Types
1 or 2	2		4		6	8
3 to 6	4	6	6	8	8	10
7 to 10 (SLC30 only)	6	8	8		10	12



* SLC30 series only.

Recommended Mounting Clip Positions

Columns	1 or 2		3 to 8		9 to 15	16 to 20*
Rows	Full Voltage	Others	Full Voltage	Others	All Types	All Types
1 or 2	2 Clips		4 Clips		6 Clips	8 Clips
3 to 6	4 Clips	6 Clips	6 Clips	8 Clips	8 Clips	10 Clips
7 to 10 (SLC30 only)	6 Clips	8 Clips	8 Clips		10 Clips	12 Clips

Assembly Order for Lamp On/Lamp Off Colors

Lamp On: Amber, Blue, Green, Red, Yellow		Lamp On: White	Lamp On: Red/Green
Lamp Off: Desired Color	Lamp Off: White	Lamp Off: White	Lamp Off: White
<p>Matte Surface (non-shiny)</p> <p>Lens Color Screen: Any Color Marking Plate: White</p>	<p>Matte Surface (non-shiny)</p> <p>Lens Marking Plate: White Color Screen: Any Color</p>	<p>Matte Surface (non-shiny)</p> <p>Lens Marking Plate: White Color Screen: White</p>	<p>Matte Surface (non-shiny)</p> <p>Lens Marking Plate: White Color Screen: White</p>