

CU/CP-U200-D relay - Miniature, large pull-in voltage range

Datasheet



Features

- Miniature plug-in / PCB relay
- Sensitive coil (40 % U_{nom})
- Instantaneous 1 C/O + 1 N/O contact
- Weld-no-transfer contacts
- Flat, square and tin plated relay pins for excellent socket connection / PCB mounting pins
- Wide range sockets
- Transparent cover
- High insulation because of flash barrier
- Optional positive mechanical keying relay to socket

Benefits

- Proven reliable
- Long term availability
- Easy to maintain
- Used in safety critical applications
- Low life cycle cost
- No maintenance

Railway compliancy

- EN 50155 Electronic equipment used on rolling stock for railway applications
- IEC 60571 Electronic equipment used on railway vehicles
- IEC 60077 Electrical equipment for rolling stock in railway applications
- IEC 60947 Low voltage switch gear and control gear
- IEC 61373 Rolling stock equipment - Shock and vibration test
- EN 50121 Electromagnetic compatibility for railway applications
- NF F 16-101/102, EN 45545-2 Fire behaviour - Railway rolling stock
- IEC 60529 European standard describes the protection class (IP-code)
- NF F 62-002 On-off contact relays and fixed connections

Description

Miniature railway relay with one change-over contact and one normally-open contact. Very sensitive relay with a large pull-in voltage range: 40 %...125 % of the nominal voltage. The contacts are weld-no-transfer contacts: they are mechanically forced in the same position. Standard with high insulation because of flash barrier. Relay for plug-in mounting (CU version) or PCB mounting (CP version).

The construction of the relay and choice of materials makes the CU/CP-U200-D relay suitable to withstand corrosive atmospheres, low and high temperatures, shock & vibrating and dry to very humid environments.

With a very compact design and a wide range of sockets, the CU/CP-U200-D relay is an easy and flexible solution to use.

Application

These relay series are designed for rolling stock applications where available space is limited. The CU/CP-U200-D is used in applications with a big variation in power supply, or with very long power lines.



CU/CP-U200-D

Technical specifications

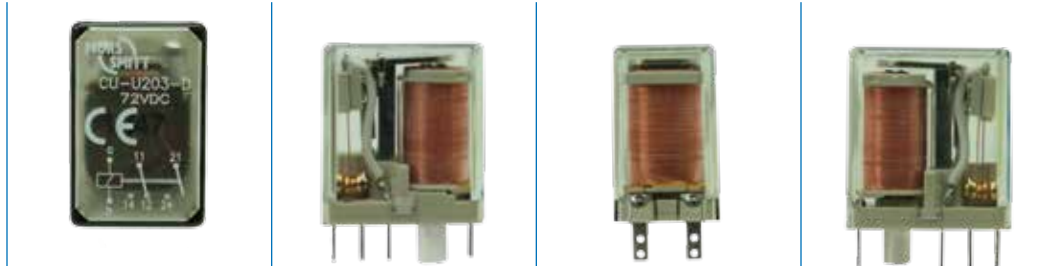

Functional and connection diagrams

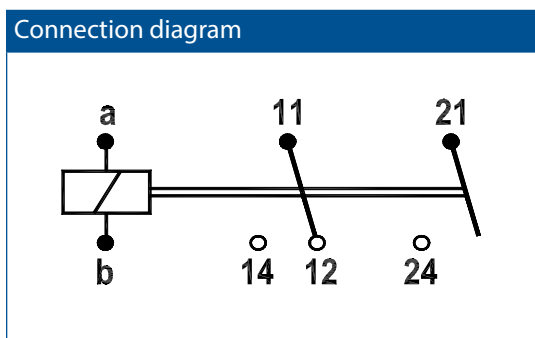
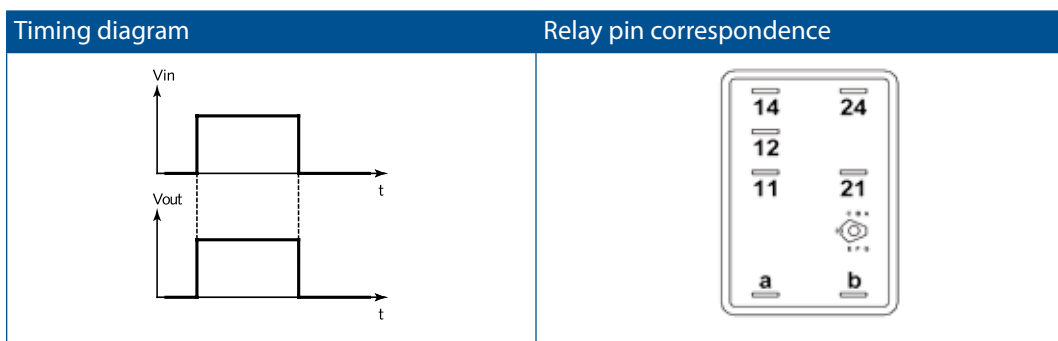

CU/CP-U200-D

Technical specifications

Coil characteristics

Operating times at nominal voltage:	
Pull-in time	≤ 15 ms
Release time	≤ 4 ms
Bounce time N/O contacts	≤ 1 ms
Bounce time N/C contacts	≤ 1 ms
Inductance L/R at U_{nom}	6 ms
Nominal power consumption	0.4 W
	Exception: 0.55 W for $U_{nom} = 110$ VDC
Operating voltage range	40 %...125 % U_{nom}

Type	U_{nom} (VDC)	U_{min} (VDC)	U_{max} (VDC)	$U_{drop-out}$ (VDC)	R_{coil} (Ω)*
U201-D	24	9.6	30	1.2	1550
U202-D	48	19.2	60	2.4	6306
U203-D	72	28.8	90	3.6	12887
U204-D	110	44	137.5	5.5	22630
U205-D	96	38.4	120	4.8	22630
U206-D	12	4.8	15	0.6	390
U207-D	36	14.4	45	1.8	3300
U210-D	120	48	150	6.0	22630

Other types on request

* The R_{coil} is measured at room temperature and has a tolerance of $\pm 10\%$

Remarks:

- U_{min} is the must-operate voltage at which the relay has picked up in all circumstances (worst-case situation), in practice the relay picks up at a lower voltage
- $U_{drop-out}$ is the must-release voltage at which the relay has dropped-out in all circumstances (worst-case situation), in practice the relay drops out at a higher voltage

Operating range at various temperatures

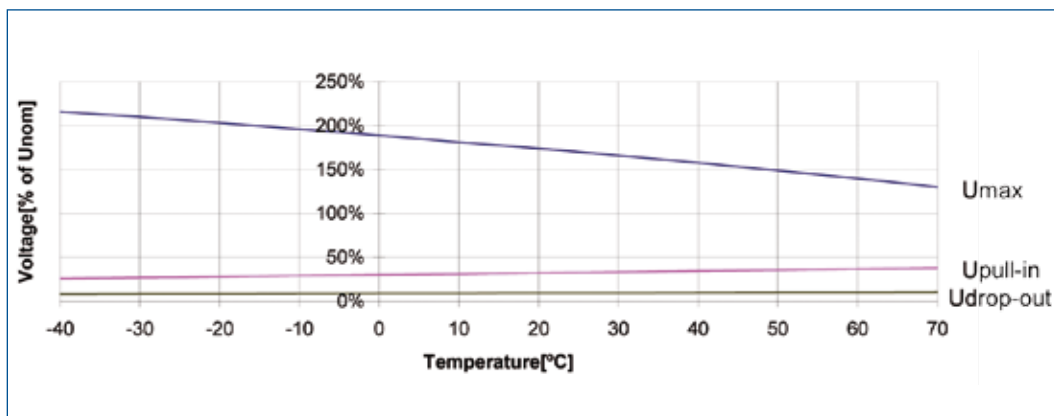

CU/CP-U200-D

Technical specifications

Contact characteristics

Amount and type of contacts	1 C/O + 1 N/O
Maximum make current	15 A
Maximum continuous current	6 A (AC1 ; IEC 60947)
Maximum switching voltage	300 VDC (then max. current = 300 mA) 250 VAC (then max. current = 2.6 A)
Minimum switching voltage	12 V
Minimum switching current	10 mA
Maximum contact resistance	15 mΩ
Maximum switching capacity	See graph page 5
Material	Ag + 0.2 μm Au (gold flash is only for storage purpose)
Contact gap	0.3 mm
Contact force	> 20 cN

Note : contacts cannot have a different position (Forced contacts, Weld-no-transfer)

Electrical characteristics

Dielectric strength	EN 50155
Pole-Pole	IEC 60255-5 4.0 kV, 50 Hz
Cont-Coil	IEC 60077 3.5 kV, 50 Hz
Insulation between open contacts	1 kV ; 50 Hz ; 1 min
Pulse Withstanding	IEC 60255-5 5 kV (1.2/50 μs)

Mechanical characteristics

Mechanical life	30 x 10 ⁶ operations
Maximum switching frequency	Mechanical: 3600 ops/h Electrical: 1200 ops/h
Weight	40 g



CU/CP-U200-D

Technical specifications

Environmental characteristics

Environmental	EN 50125-1 and IEC 60077-1
Vibration	IEC 61373, Category I, Class B, Body mounted (relay in socket including retaining clip)
Shock	IEC 61373, Category I, Class B, Body mounted (relay in socket including retaining clip)
Operating temperature	-40 °C...+85 °C (-25 °C...+85 °C option E)
Humidity	95% (condensation is permitted temporarily)
Salt mist	IEC 60068-2-11, class ST4
Damp heat	IEC 60068-2-30, Test method Db variant 1
Protection	IEC 60529, IP40 (relay on socket)
Fire & smoke	NF F 16101, NF F16102, EN 45545-2
Insulation materials	Cover: polycarbonate Base: polyester

Dimensions (mm)

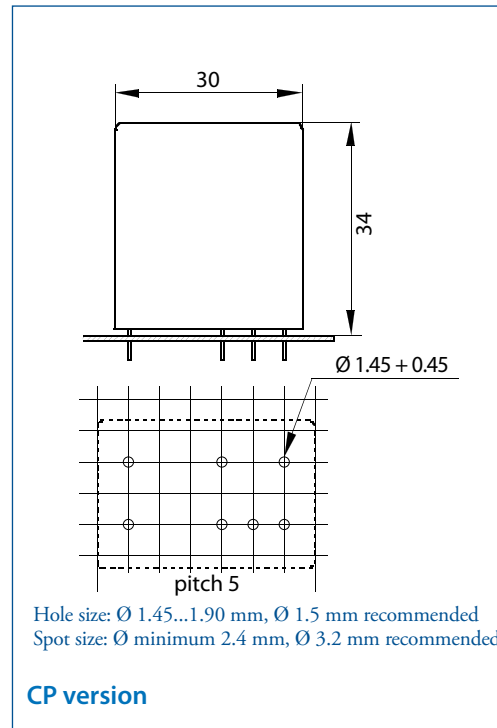
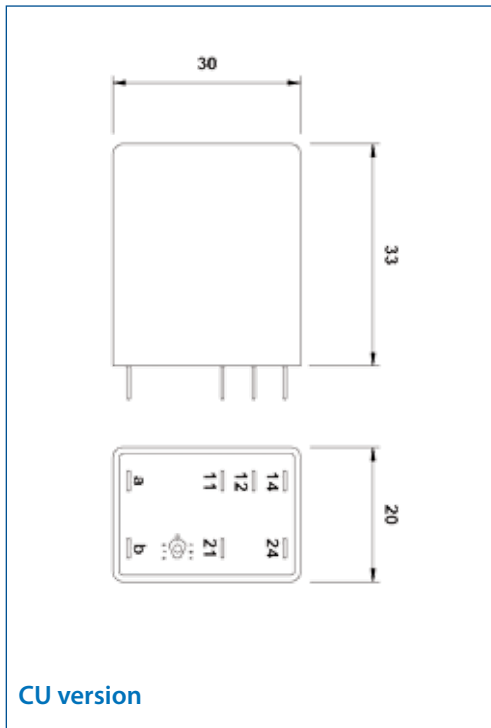

CU/CP-U200-D

Technical specifications

Options

Code	Description	Remark	Cannot be combined with:
E *	Au; Gold plated contacts (10 µm)		
* Gold plated contacts characteristics			
Material		Ag, 10 µm gold plated	
Maximum switching voltage		60 V (higher voltages may be possible, contact Mors Smitt for more information)	
Maximum switching current		400 mA (at higher rate gold will evaporate, then the standard silver contact rating of minimum 10 mA and 12 V is valid)	
Minimum switching voltage		5 V	
Minimum switching current		1 mA	



CU/CP-U200-D

Technical specifications

Switching capacity and contact life

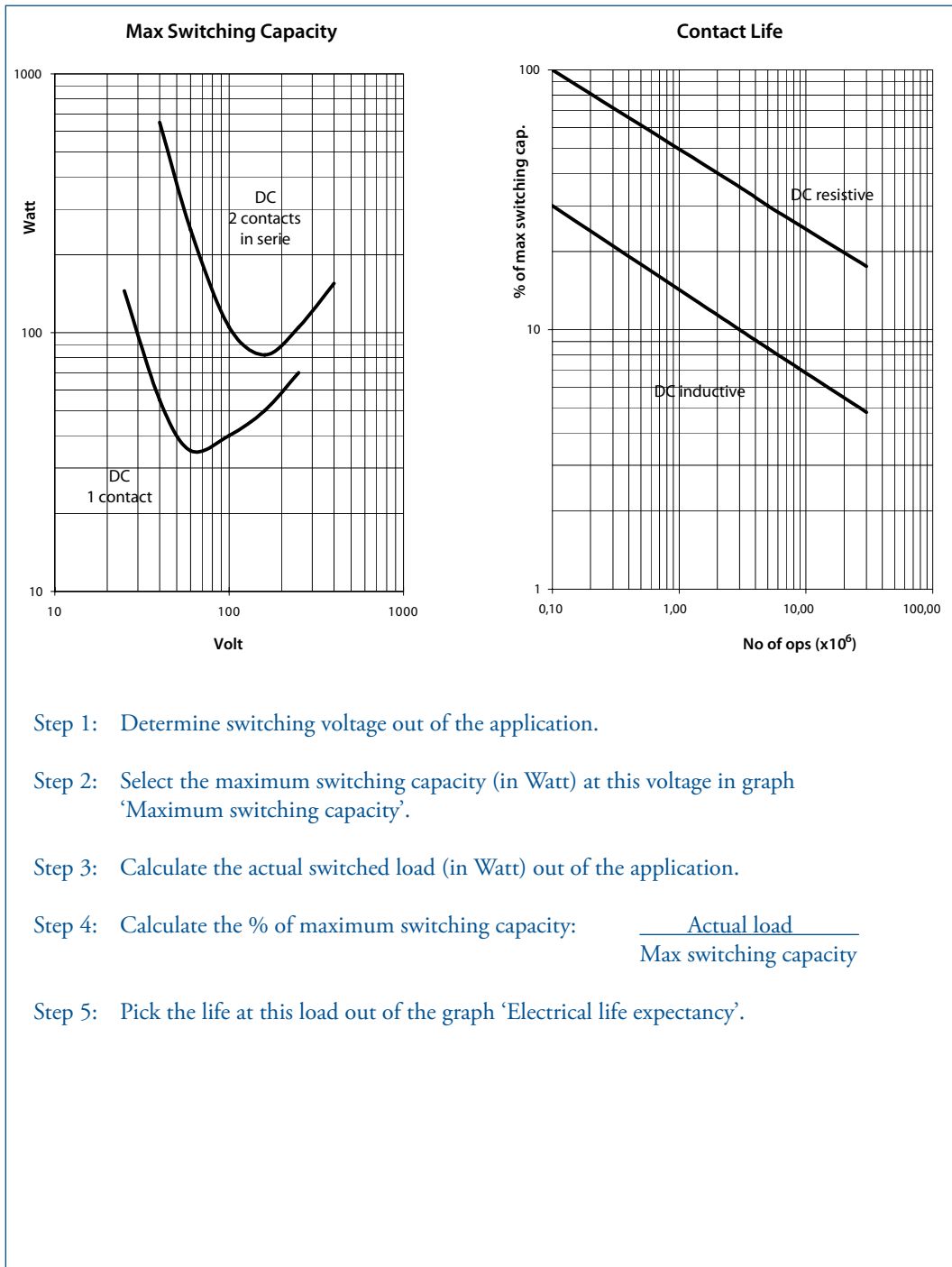

CU/CP-U200-D

Mounting possibilities / sockets



General

The CU/CP-U200-D can be mounted in any position except with the connecting pins pointing upwards.

Relays and sockets are all tested to the IEC 61373 but when the CU-Uxxx relay is mounted in a socket suitable for rail mounting it is not recommended to mount the socket with the spring side up (that means for recommended rail mounting: contacts 14-12-22-24 upwards).

Surface/wall mounting

338001000	V10	Screw socket, wall mount, front connection (2.5 mm ²)
338001100	V11	Screw socket, wall mount, with back EMF diode, front connection (2.5 mm ²)
Various	V15	Screw socket, wall mount, back EMF diode + LED, front connection (2.8 mm ²)

Wall / rail mounting

338001400	V17	Cage clamp socket, wall /rail mount, front connection *
338001401	V17-D	Cage clamp socket, wall /rail mount, front connection, with back EMF diode *
338001402	V17-Q1	Cage clamp socket, wall /rail mount, front con., with double zener diode, 12 V..30 V *
338001403	V17-Q2	Cage clamp socket, wall /rail mount, front con., with double zener diode, 30 V..45 V *
338001404	V17-Q3	Cage clamp socket, wall /rail mount, front con., with double zener diode, 45 V..65 V *
338001405	V17-Q4	Cage clamp socket, wall /rail mount, front con., with double zener diode, 65 V..90 V *
338001406	V17-Q5	Cage clamp socket, wall /rail mount, front con., with double zener diode, 90 V..150 V *

* Wire size: max 2.5 mm²

PCB mounting

338200100	V14	PCB-soldering socket, only for CP-Uxxx series
-----------	-----	---

Retaining clip + rail clip

See datasheets of the sockets

CU/CP-U200-D

Keying

Mechanical keying relay and socket (optional)

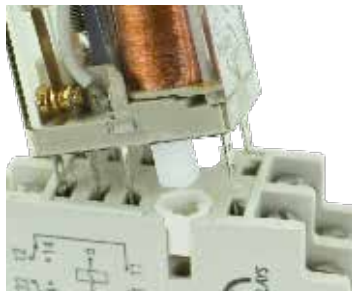

Function:

- To prevent wrong installation
- To prevent damage to equipment
- To prevent unsafe situations

Using keyed relays and sockets prevents a relay being inserted in a wrong socket. For example it prevents placing a 24 VDC relay in a 110 VDC circuit. Positive discrimination is possible per different function, coil voltage, timing, monitoring, safety and non-safety.

The CU-Series relay socket keying option gives 8 possibilities. Upon ordering the customer simply indicates the need for the optional keying. Mors Smitt will assign a code to the relay and fix the pins into the relay. The sockets are supplied with loose key receptacles. Inserting the keys into the socket is very simple and self explaining.

Remark: sockets and relay shown are only examples.

Top view socket

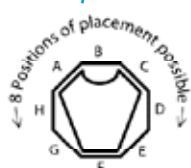
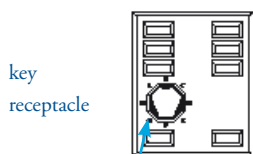

Example keying position F on socket

Bottom view relay

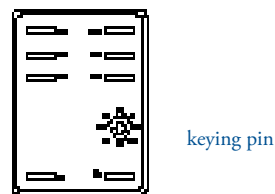

Example keying position F on relay



CU/CP-U200-D

Instructions

Installation, operation & inspection

Installation

Before installation or working on the relay: disconnect the power supply first!

Install socket and connect wiring according to the terminal identification. Plug relay into the socket ensuring there is no gap between the bottom of relay and the socket. Reverse installation into the socket is not possible due to the mechanical blocking of the standard keying inside CU relays. Check to ensure that the coil connection polarity is not reversed. Relays can be mounted tightly together to save space.

Warning!

- Never use silicon in the proximity of the relays.
- Do not use the relay in the presence of flammable gas as the arc generated from switching could cause ignition.
- To remove relays from the socket, pull the relay in a straight line out of the socket. Sideway movement may cause damage to the coil wires. When a V17 socket is used, extracting tool A171 (502110000) is required.

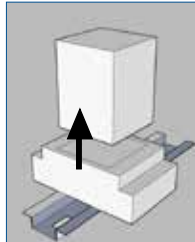
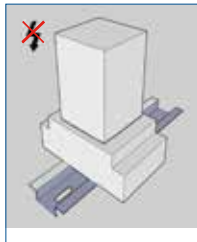

Operation

Always use the relay within its specifications. After installation always apply the rated voltage to the coil to check correct operation. Long term storage may corrode the tin plating on the relay pins. When plugging the relay into the socket, the female bifurcated receivers will automatically cut through the corrosion on the pins and guarantee a reliable connection.

Before actual use of relays, it is advised to switch the load several times with the contacts. The contacts will both be electrically and mechanically cleaned due to the positive wiping action. Sometimes a contact can build up increased contact resistance ($\leq 15 \text{ m}\Omega$ when new). When using silver contacts one can clean the contact by switching a contact load a few times using $>24 \text{ VDC}$ & $\sim 2 \text{ A}$. Increased contact resistance is not always problematic, as it depends on circuit conditions. In general a contact resistance of 1Ω is no problem, consult Mors Smitt for more information.

Condensation in the relay is possible when the coil is energised (warm) and the outside, environmental temperature is cold. This is a normal phenomenon and will not affect the function of the relay. Materials in the relay have no hygroscopic properties.

Inspection

Correct operation of the relay can easily be checked as the transparent cover provides good visibility of the moving contacts. If the relay does not seem to operate correctly, check for presence of the appropriate coil voltage and polarity using a suitable multimeter. If coil voltage is present, but the relay does not operate, a short circuit of the suppression diode if present in the socket, is possible (this may be due to the coil connection having been reversed).

If the relay doesn't work after inspection, replace the relay unit with a similar model. Do not attempt to open the relay cover or try to repair. Contacts are calibrated and in balance, touching can affect proper operation. Also re soldering may affect correct operation.

Most relay defects are caused by installation faults such as over voltage, spikes/transients, high/short current far exceeding the relay specifications. When returning the relays for investigation, please provide all information on the RMA form. Send defective relays back to the manufacturer for repair or replacement. Normal wear and tear or external causes are excluded from warranty.



CU/CP-U200-D

Ordering scheme

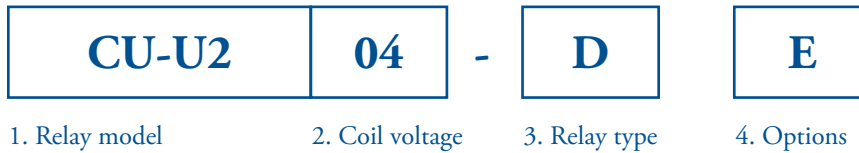

This example represents a **CU-U204-DE**.

Description: CU-U200 plug-in relay, U_{nom} : 110 VDC, relay type D, gold plated contacts

1. Relay model

CU-U2	Plug-in model
CP-U2	PCB model

2. Coil voltages

01	24 VDC
02	48 VDC
03	72 VDC
04	110 VDC
05	96 VDC
06	12 VDC
07	36 VDC

3. Relay type

D

4. Options

E	Gold plated contacts
----------	----------------------

Upon ordering indicate keying if necessary





www.morssmitt.com



Mors Smitt France SAS

Tour Rosny 2, Avenue du Général de Gaulle,

F - 93118 Rosny-sous-Bois Cedex, FRANCE

T +33 (0)1 4812 1440, F +33 (0)1 4855 9001

E sales@msrelais.com

Mors Smitt Asia Ltd.

807, Billion Trade Centre, 31 Hung To Road

Kwun Tong, Kowloon, HONG KONG SAR

T +852 2343 5555, F +852 2343 6555

E info@morssmitt.hk

Mors Smitt B.V.

Vrieslantlaan 6, 3526 AA Utrecht,

NETHERLANDS

T +31 (0)30 288 1311, F +31 (0)30 289 8816

E sales.msbv@wabtec.com

Mors Smitt Technologies Inc.

1010 Johnson Drive,

Buffalo Grove, IL 60089-6918, USA

T +1 847 777 6497, F +1 847 520 2222

E salesmst@wabtec.com

Mors Smitt UK Ltd.

Doulton Road, Cradley Heath

West Midlands, B64 5QB, UK

T +44 (0)1384 567 755, F +44 (0)1384 567 710

E sales.msuk@wabtec.com