

# TDB2-U200 relay - Timer, delay-on, 2 pole

## Datasheet



### Description

Plug-in electronic railway timer relay with two change-over contacts. When the relay is activated there is a delay on pull-in. The delay time is adjustable with a lockable knob. The relay can also be supplied with a fixed time delay (no knob)

The construction of the relay and choice of materials makes the TDB2-U200 relay suitable to withstand low and high temperatures, shock & vibrating and dry to humid environments.

No external retaining clip needed as integrated 'snap-lock' will hold relay into socket under all circumstances and mounting directions.

Compact design, choice of many options and a wide range of sockets makes the TDB2-U200 relay an easy and flexible solution to use.

### Application

These relay series are designed for demanding rolling stock applications. The TDB2-U200 is used in applications where a time delay is necessary after activating the relay.

### Features

- Time delay relay, delay on pull-in
- Compact plug-in design
- 2 C/O contacts
- Delay time adjustable with lockable knob
- Also available with fixed time delay
- Total time delay range: 0.1 s...30 min
- Weld-no-transfer contacts
- Flat, square and silver plated relays pins for excellent socket connection
- Wide range sockets
- Integrated snap lock
- Transparent cover
- Optional positive mechanical keying relay to socket

### Benefits

- Proven reliable
- Long term availability
- Easy to maintain
- Low life cycle cost
- No maintenance

### Railway compliancy

- EN 50155 Electronic equipment used on rolling stock for railway applications
- IEC 60571 Electronic equipment used on railway vehicles
- IEC 60077 Electrical equipment for rolling stock in railway applications
- IEC 60947 Low voltage switch gear and control gear
- IEC 61373 Rolling stock equipment - Shock and vibration test
- IEC 60947-5-4 Electromechanical components for control applications. This standard examines both coil and contact specifications in depth
- EN 50121 Electromagnetic compatibility for railway applications
- NF F 16-101/102, EN 45545-2 Fire behaviour - Railway rolling stock
- NF F 62-002 On-off contact relays and fixed connections



# TDB2-U200 relay

## Technical specifications

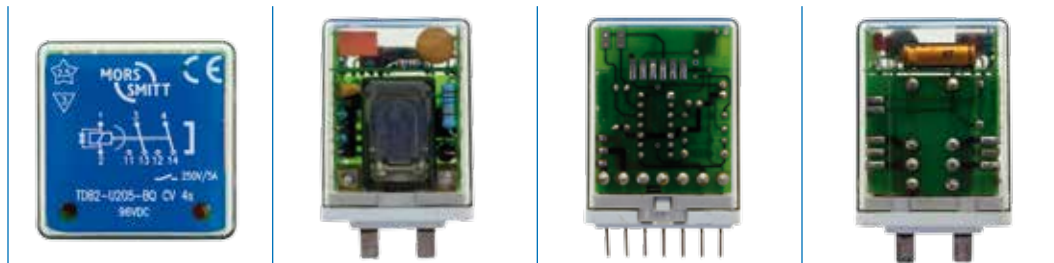

### Functional and connection diagrams

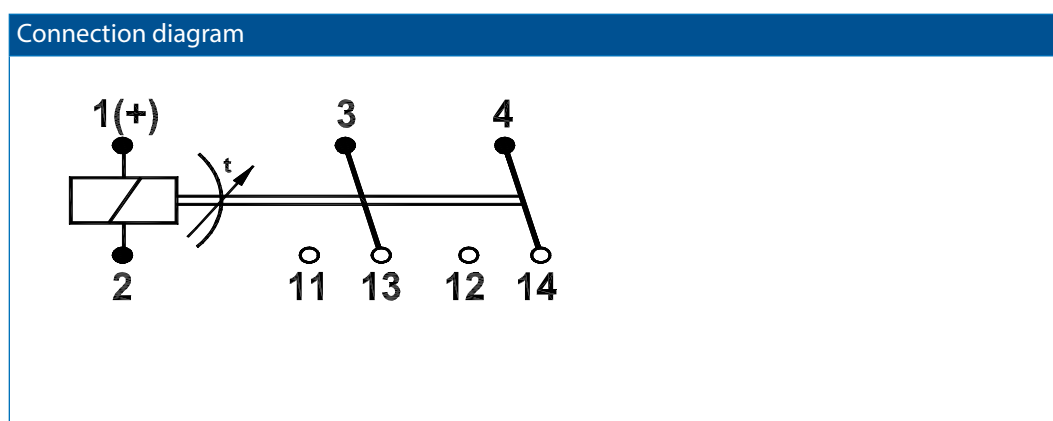
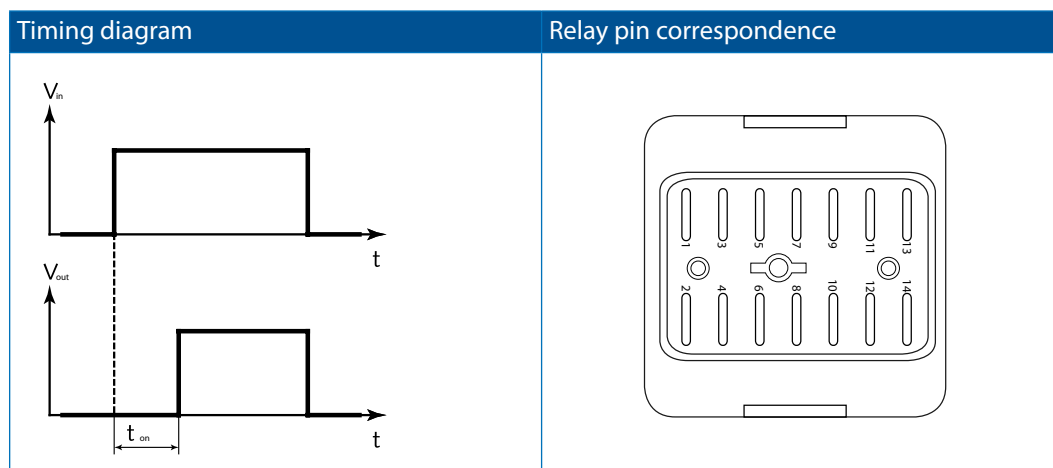

# TDB2-U200 relay

## Technical specifications

### Time delay specifications

Time delay function	Delay on pull-in
Available time ranges, adjustable (xx)	0.1...1 s      0.3...3 s      0.6...6 s 1...10 s      3...30 s      6...60 s 0.3...3 min      0.6...6 min      1 ...10 min 3...30 min
Accuracy - adjustment	< 10 % of full scale value After adjusting / fixed time setting: no variation in setpoint
Accuracy - repeatability	± 0.5 %
Time variation - vs. voltage variation	± 0.05 % / % $U_{nom}$
Time variation - vs. temperature variation	± 0.02 % / K
Recovery time	< 0.2 s
Pull-in time	Depending on pull-in time setting (xx)
Release time	< 40 ms
Maximum permissible ripple	50 %
<p>Example time delay : Time range 0.3...3 s            Time delay set on 2 s : delay will be between 1.7 s...2.3 s            For example: 2.0 s. The ambient temperature is 40 degrees Celsius which is 20 degrees different compared to the standard 20 degrees Celsius. This results in 0.4 % extra time variation. The applied voltage is 30 % lower than the nominal voltage. This results in 1.5 % extra time variation. The total maximum time variation is then 0.5 % (repeatability) + 0.4 % (temperature variation) + 1.5 % (voltage variation) = 2.4 %. In this case every new pulse will be between 1.95 s and 2.05 s.</p>	

### Coil characteristics

Operating voltage range	0.7...1.25 $U_{nom}$
Nominal power consumption	during delay time < 0.5 W after switching on < 2.0 W

Type	$U_{nom}$ (VDC)	$U_{min}$ (VDC)	$U_{max}$ (VDC)
TDB2-U201-xx	24	16.8	30
TDB2-U202-xx	48	33.6	60
TDB2-U203-xx	72	50.4	90
TDB2-U204-xx	110	77.0	138
TDB2-U205-xx	96	67.2	120
TDB2-U207-xx	36	25.2	45

Other types on request

Remarks:

- $U_{min}$  is the must-operate voltage at which the relay has picked up in all circumstances (worst-case situation), in practice the relay picks up at a lower voltage



# TDB2-U200 relay

## Technical specifications

### Contact characteristics

Amount and type of contacts	2 C/O
Maximum make current	15 A
Maximum continuous current	6 A (AC1 ; IEC 60947)
Maximum switching voltage	300 VDC (then max. current = 300 mA) 250 VAC (then max. current = 2.6 A)
Maximum switching capacity	See graph page 6
Contact resistance	15 mΩ (initial)
Material	Ag standard (optional Au on Ag)
Contact gap	0.3 mm
Contact force	> 200 mN

Note : contacts cannot have a different position (forced contacts, weld-no-transfer)

### Electrical characteristics

Dielectric strength	EN 50155
Pole-pole	IEC 60255-5      2 kV, 50 Hz, 1 min
Cont-coil	IEC 60077        2 kV, 50 Hz, 1 min
Insulation between open contacts	1 kV; 50 Hz; 1 min
Pulse withstanding	IEC 60255-5      5 kV (1.2 / 50 μs)
EMC	EN 50121-3-2 compliant

### Mechanical characteristics

Mechanical life	30 x 10 <sup>6</sup> operations
Maximum switching frequency	Mechanical: 3600 ops/h Electrical: 1200 ops/h
Maximum torque value screw to lock knob	0.15 Nm
Weight	110 g (without options)



# TDB2-U200 relay

## Technical specifications

### Environmental characteristics

Environmental	EN 50125-1 and IEC 60077-1
Vibration	IEC 61373, Category I, Class B, Body mounted
Shock	IEC 61373, Category I, Class B, Body mounted
Operating temperature	-25 °C...+70 °C (with option C and option Y: -40°C)
Humidity	80 %
Salt mist	IEC 60068-2-11, class ST4
Damp heat	IEC 60068-2-30, Test method Db variant 1
Protection	IEC 60529, IP40 (relay on socket)
Fire & smoke	NF F 16-101, NF F16-102, EN 45545-2
Insulation materials	Cover: polycarbonate Base: polyester



# TDB2-U200 relay

## Technical specifications

### Dimensions (mm)

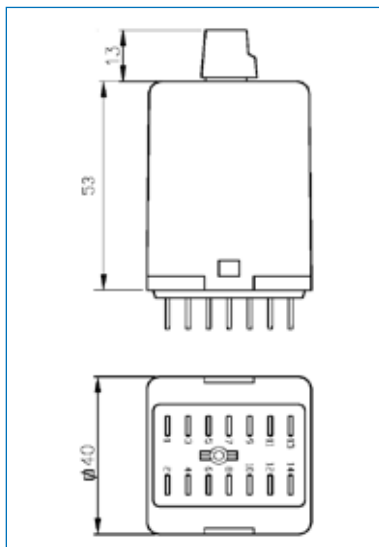

### Options

Code	Description	Remark	Cannot be combined with:
B	Magnetic arc blow out		
C	Low temperature (-40 °C)		E**
E*	Au; Gold plated contacts (10 µm)		C**
K	Extra dust protection	Only for fixed time setting	
Q	Double zener diode over input	Polarity independent	
Y	Double make/double break contacts	1 C/O DM/DB, -40 °C	
Keying	Coil coding relay and socket		
Colour coding	Coloured cover for coil voltage coding		

* Gold plated contacts characteristics	
Material	Ag, 10 µm gold plated
Maximum switching voltage	60 V (higher voltages may be possible, contact Mors Smitt for more information)
Maximum switching current	400 mA (at higher rate gold will evaporate, then the standard silver contact rating of minimum 10 mA and 12 V is valid)
Minimum switching voltage	5 V
Minimum switching current	1 mA
** Options C and E combined is possible depending on the application. Contact Mors Smitt for more information.	



# TDB2-U200 relay

## Technical specifications

### Switching capacity and contact life

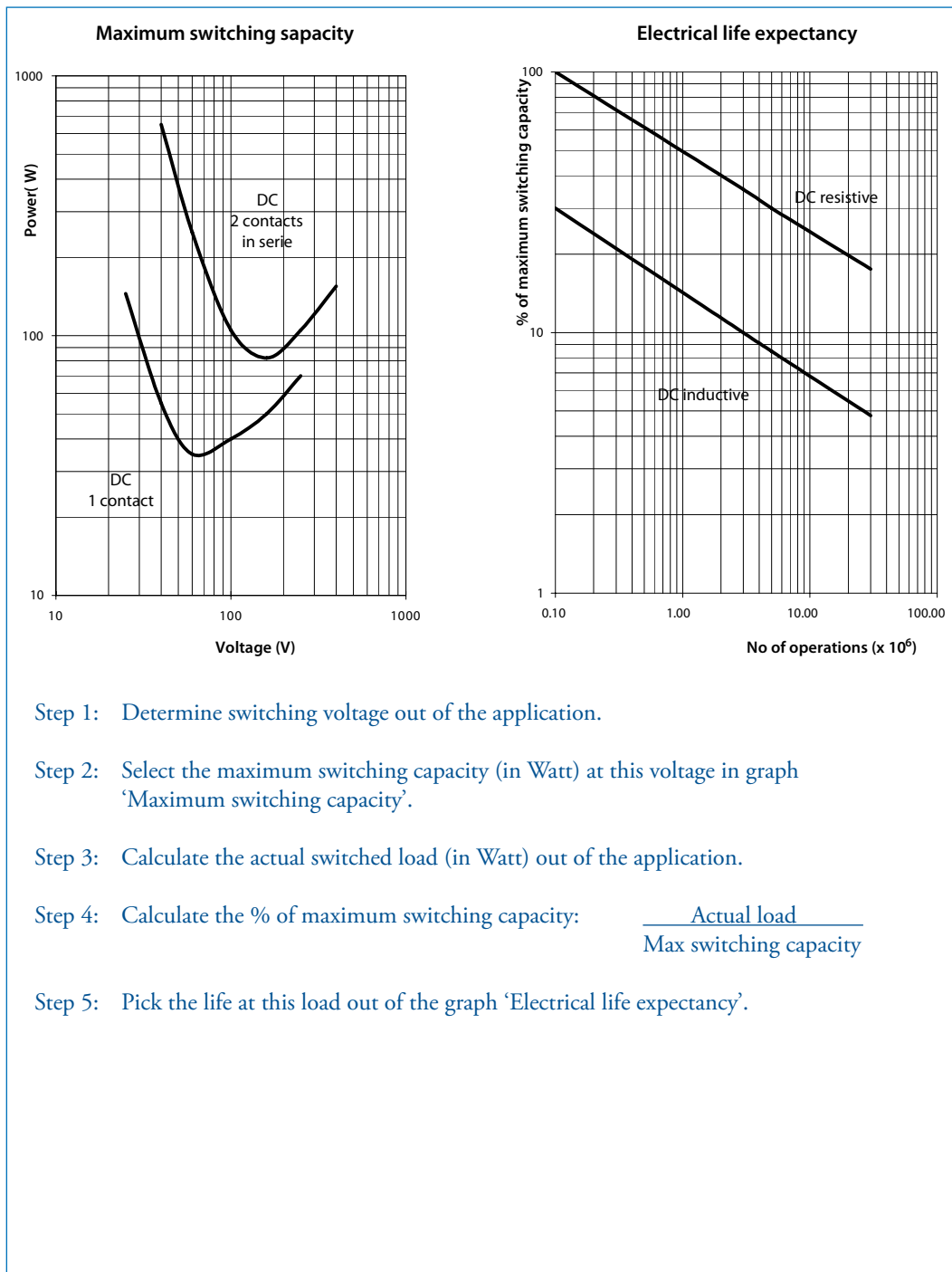

# TDB2-U200 relay Sockets

## Mounting possibilities/sockets



### Surface/wall mounting

338000302	V22BR	Screw socket, wall mount, front connection (9 mm terminals)
338000580	V23	Screw socket, wall mount, front connection (7.5 mm terminals)
338000610	V29	Spring clamp socket, wall mount, front dual connection (2.5 mm <sup>2</sup> )

### Rail mounting

338000580	V23	Screw socket, rail mount, front connection (7.5 mm terminals)
338000402	V23BR	Screw socket, rail mount, front connection (9 mm terminals)
338000610	V29	Spring clamp socket, rail mount, front dual connection (2.5 mm <sup>2</sup> )

### Panel/flush mounting

338100100	V3	Solder tag socket, panel mount, rear connection
328400100	V26	Crimp contact socket, panel mount, rear connection, A260 crimp contact
338000560	V31	Faston connection socket, rear dual connection (6.3 mm)
338000570	V33	Spring clamp socket, flush mount, rear dual connection (2.5 mm <sup>2</sup> )

### PCB mounting

338000561	V32	PCB soldering socket
-----------	-----	----------------------

For more details see datasheets of the sockets



# TDB2-U200 relay

## Keying

### Mechanical keying relay and socket (optional)

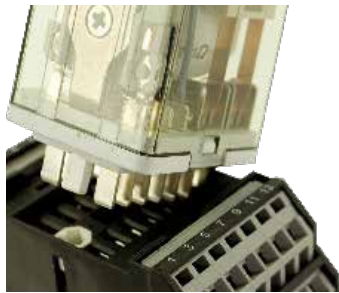

Function:

- To prevent wrong installation
- To prevent damage to equipment
- To prevent unsafe situations

Using keyed relays and sockets prevents a relay is inserted in a wrong socket. For example it prevents that a 24 VDC relay is put in a 110 VDC circuit. Positive discrimination is possible per different function, coil voltage, timing, monitoring, safety and non-safety.

The D-relay socket keying option gives  $8 \times 8 = 64$  possibilities. Upon ordering the customer simply indicates the need for the optional keying. Mors Smitt will assign a code to the relay and fix the pins into the relay. The sockets are supplied with loose key receptacles. Inserting the keys into the socket is very simple and self explaining.

Remark: Sockets and relay shown are only examples.

Top view socket

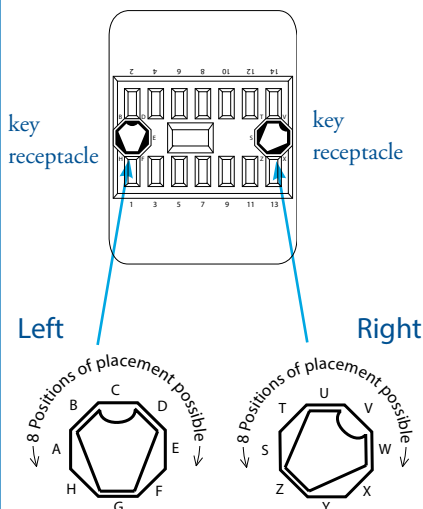

Example keying position G-Z on socket

Bottom view relay

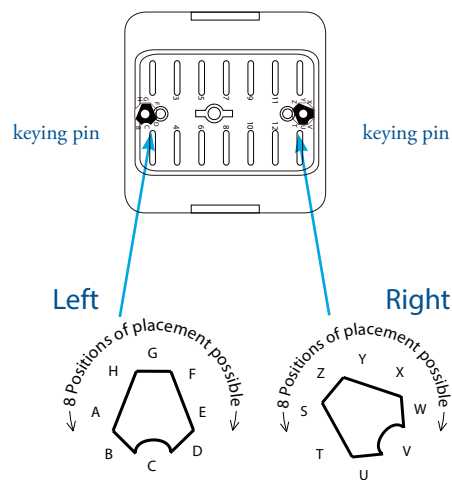

Example keying position G-Z on relay



# TDB2-U200 relay

## Instructions

### Installation, operation & inspection

#### Installation

Before installation or working on the relay: disconnect the power supply first! Install socket and connect wiring according to the terminal identification. Plug relay into the socket ensuring there is no gap between the bottom of relay and the socket. Reverse installation into the socket is not possible due to the mechanical blocking snap-lock feature. Check to ensure that the coil connection polarity is not reversed. Relays can be mounted tightly together to save space.

When rail mounting is used, always mount the socket in the direction of the UP arrow, to have proper fixation of the socket on the rail.

#### Warning!

- Never use silicon in the proximity of the relays.
- Do not use the relay in the presence of flammable gas as the arc generated from switching could cause ignition.
- To remove relays from the socket, employ up and down lever movements. Sideway movement may cause damage to the coil wires.

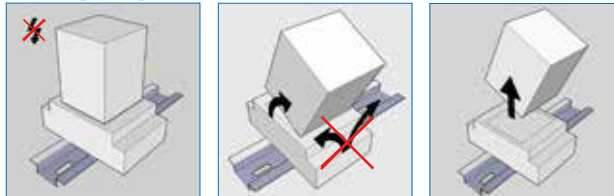

#### Operation

After installation always apply the rated voltage to the coil to check correct operation.

Long term storage may corrode the silver on the relay pins. When plugging the relay into the socket, the female bifurcated or trifurcated receivers will automatically cut through the corrosion on the pins and guarantee a reliable connection.

Before actual use of relays, it is advised to switch the load several times with the contacts. The contacts will both be electrically and mechanically cleaned due to the positive wiping action. Sometimes a contact can build up increased contact resistance ( $\leq 15 \text{ m}\Omega$  when new). When using silver contacts one can clean the contact by switching a contact load a few times using  $>24 \text{ VDC}$  &  $-2 \text{ A}$ . Increased contact resistance is not always problematic, as it depends on circuit conditions. In general a contact resistance of  $1 \Omega$  is no problem, consult Mors Smitt for more information.

Condensation in the relay is possible when the coil is energised (warm) and the outside, environmental temperature is cold. This is a normal phenomenon and will not affect the function of the relay. Materials in the relay have no hygroscopic properties.

#### Inspection

Correct operation of the relay can easily be checked as the transparent cover provides good visibility of the moving contacts. If the relay does not seem to operate correctly, check for presence of the appropriate coil voltage and polarity using a suitable multimeter. If a LED is fitted, it indicates voltage presence to the coil. If coil voltage is present, but the relay does not operate, a short circuit of the suppression diode is possible (This may be due to the coil connection having been reversed).

If the relay doesn't work after inspection, replace the relay unit with a similar model. Do not attempt to open the relay cover or try to repair. Contacts are calibrated and in balance, touching can affect proper operation. Also re soldering may affect correct operation. Since 2009 relays have tamper proof seals fitted and once broken, warranty is void.

Most relay defects are caused by installation faults such as over voltage, spikes/transients, high/short current far exceeding the relay specifications. When returning the relays for investigation, please provide all information on the RMA form. Send defective relays back to the manufacturer for repair or replacement. Normal wear and tear or external causes are excluded from warranty.



# TDB2-U200 relay

## Ordering scheme

Configuration:



1. Relay model

2. Coil voltage

3. Options

4. Time range

This example represents a **TDB2-U204-B 1 - 10 s**

**Description:** TDB2 - U200 relay,  $U_{nom}$ : 110 VDC, magnetic arc blow out, time range 1...10 s

1. Relay model

**TDB2 - U2**

2. Coil voltage

<b>01</b>	24 VDC
<b>02</b>	48 VDC
<b>03</b>	72 VDC
<b>04</b>	110 VDC
<b>05</b>	96 VDC
<b>07</b>	36 VDC

3. Options

<b>B</b>	Magnetic arc blow out
<b>C</b>	Low temp. (-40 °C)
<b>E</b>	Gold plated contacts
<b>K</b>	Special dust protection (only for fixed time setting)
<b>Q</b>	Double zener diode
<b>Y</b>	Double make / double break (Y=-40 °C)

Upon ordering indicate keying if necessary.

4. Time range

<b>0.1...1 s</b>	<b>0.3...3 min</b>
<b>0.3...3 s</b>	<b>0.6...6 min</b>
<b>0.6...6 s</b>	<b>1...10 min</b>
<b>1...10 s</b>	<b>3...30 min</b>
<b>3...30 s</b>	<b>or fixed (no knob)</b>
<b>6...60 s</b>	





DS-TDB2-U200 V1.3 March 2014



[www.morssmitt.com](http://www.morssmitt.com)



Mors Smitt France SAS

Tour Rosny 2, Avenue du Général de Gaulle,

F - 93118 Rosny-sous-Bois Cedex, FRANCE

T +33 (0)1 4812 1440, F +33 (0)1 4855 9001

E [sales@msrelais.com](mailto:sales@msrelais.com)

Mors Smitt Asia Ltd.

# 807, Billion Trade Centre, 31 Hung To Road

Kwun Tong, Kowloon, HONG KONG SAR

T +852 2343 5555, F +852 2343 6555

E [info@morssmitt.hk](mailto:info@morssmitt.hk)

Mors Smitt B.V.

Vrieslantlaan 6, 3526 AA Utrecht,

NETHERLANDS

T +31 (0)30 288 1311, F +31 (0)30 289 8816

E [sales.msbv@wabtec.com](mailto:sales.msbv@wabtec.com)

Mors Smitt Technologies Inc.

1010 Johnson Drive,

Buffalo Grove, IL 60089-6918, USA

T +1 847 777 6497, F +1 847 520 2222

E [salesmst@wabtec.com](mailto:salesmst@wabtec.com)

Mors Smitt UK Ltd.

Doulton Road, Cradley Heath

West Midlands, B64 5QB, UK

T +44 (0)1384 567 755, F +44 (0)1384 567 710

E [sales.msuk@wabtec.com](mailto:sales.msuk@wabtec.com)

(c) Copyright 2014

All rights reserved. Nothing from this edition may be multiplied, or made public in any form or manner, either electronically, mechanically, by photocopying, recording, or in any manner, without prior written consent from Mors Smitt. This also applies to accompanying drawings and diagrams. Due to a policy of continuous development Mors Smitt reserves the right to alter the equipment specification and description outlined in this datasheet without prior notice and no part of this publication shall be deemed to be part of any contract for the equipment unless specifically referred to as an inclusion within such contract. Mors Smitt does not warrant that any of the information contained herein is complete, accurate, free from potential errors, or fit for any particular purpose. Mors Smitt does not accept any responsibility arising from any party's use of the information in this document.