

# V29 socket - Spring clamp terminal, wall/rail mount

## Datasheet



### Description

The V29 is a surface / wall and 35 mm rail mount relay socket. The V29 socket has two highly reliable spring clamp terminals per relay contact, so looping/daisy chaining can be done on the socket and no external connector or terminal is needed.

The spring clamp terminal makes a quick connection possible by pressing the spring with a flat-bladed screwdriver and inserting the stripped wire. Solid and (fine) stranded wires up to 2.5 mm<sup>2</sup> can be inserted in the spring clamp terminals. This quick & easy wiring method saves up to 75% wiring time compared with classic technology, like screw terminals.

To prevent fault relay placement the socket can be equipped with mechanical keying to accept only designated identical keyed relays.

### Application

The V29 relay socket is suitable for general railway applications with a space saving design. Installation and replacement of relays is made easy and cost saving.

Suitable for all D-U relay series.

### Features

- Surface / wall and 35 mm rail mount
- Sturdy spring clamp terminals
- Twin connection per relay contact
- No internal solderings / connections
- Touch proof IP20
- Height saving 35 mm rail mounting
- Suitable for all D-U relay series
- Easy & quick installation (up to 75% reduction of wiring time)
- Positive mechanical keying
- Trifurcated female receiver for tight grip relay pin
- Clear terminal ID

### Benefits

- Proven reliable
- Long term availability
- Easy to maintain
- Low life cycle cost
- No maintenance

### Railway compliancy

- EN 50155 Electronic equipment used on rolling stock for railway applications
- IEC 60571 Electronic equipment used on railway vehicles
- NF F 16-101/102, TS 45545-2 Fire behaviour - Railway rolling stock
- IEC 60715 Dimensions of low voltage switchgear and controlgear - mounting rail
- NF F 62-002 On-off contact relays and fixed connections



# V29 socket

## General technical specifications

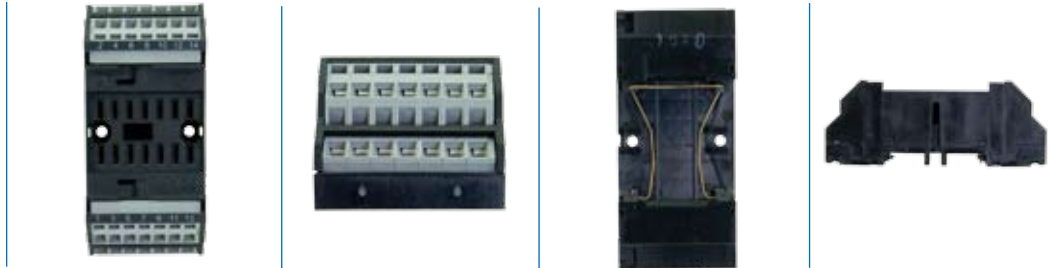

### Technical characteristics

Contact rating	10 A
Dielectric strength	IEC 60255 / IEC 60571, 3500 V, 50 Hz, 1 min
Protecting category	IEC 60529, IP20
Mounting	Surface / wall and 35 mm rail
Max. ambient temperature	80 °C
Weight	90 g
Dimensions	87 x 40 x 34.1 mm
Wire size	0.08 - 2.5 mm <sup>2</sup>
Wire stripping length	6 mm
Material	Polyamide 66, 30% glass
Socket contacts	Spring clamp terminal
Max. torque value mounting screws	1.0 Nm
Accessories	A104 Key receptacle

### Connection diagram

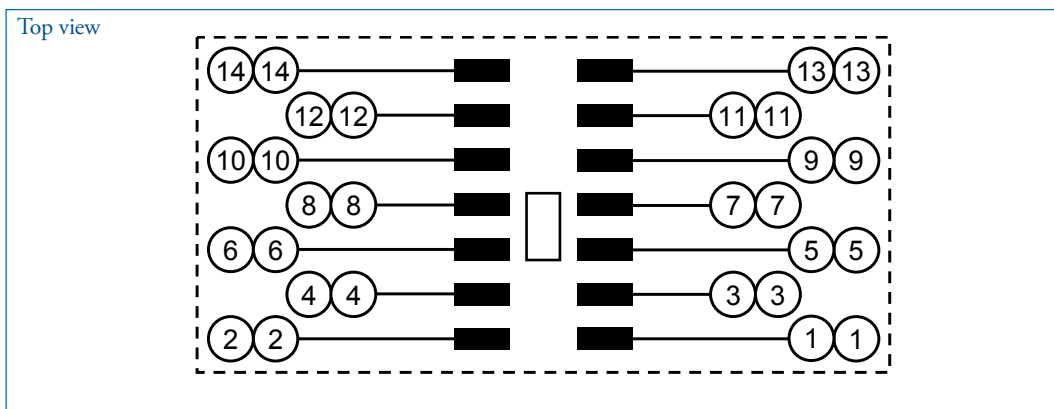

# V29 socket

## Drawings & dimensions

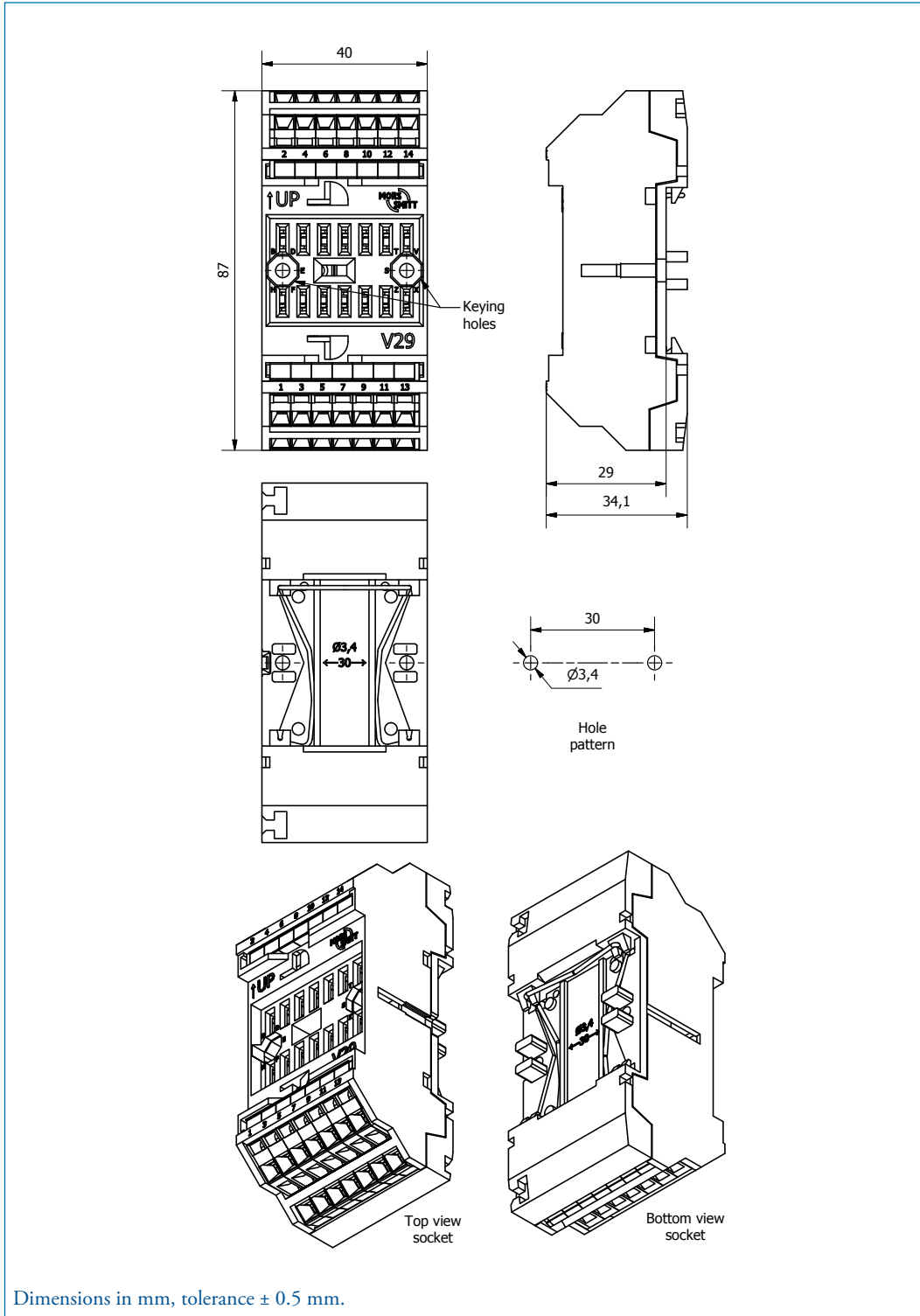

# V29 socket

## Technical specifications

### Socket for 8 contact relays

V99 spring clamp terminal relay socket for 8 contact relays (D8 or KDN series)

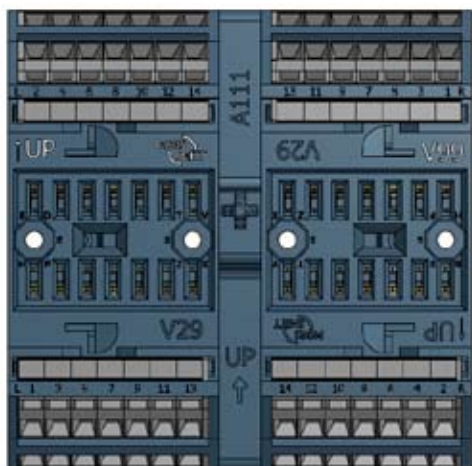

For details see datasheet V99.

### Tri-furcated female receiver for tight grip relay pin

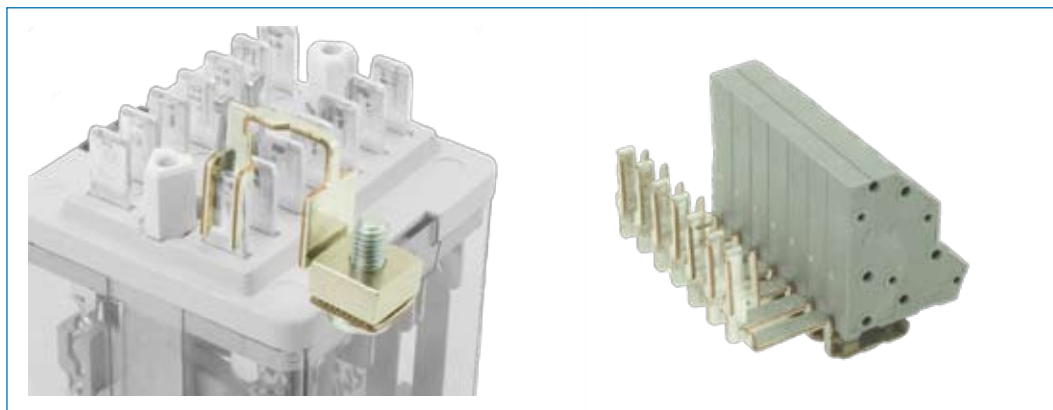

# V29 socket Keying

## Mechanical keying relay and socket (optional)



Function:

- To prevent wrong installation
- To prevent damage to equipment
- To prevent unsafe situations

Use keyed relays and sockets prevents a relay being inserted in a wrong socket. For example it prevents placing a 24 VDC relay in a 110 VDC circuit. Positive discrimination is possible per different function, coil voltage, timing, monitoring, safety and non-safety.

The D-series relay socket keying option gives  $8 \times 8 = 64$  possibilities. Upon ordering the customer simply indicates the need for the optional keying. Mors smitt will assign a code to the relay and fix the pins into the relay. The sockets are supplied with loose key receptacles. Inserting the keys into the socket is very simple and self explaining.

Remark: socket and relay type are only examples.

Top view socket

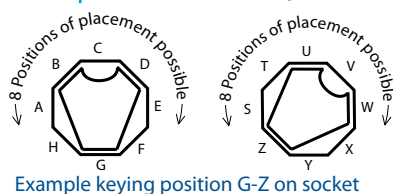
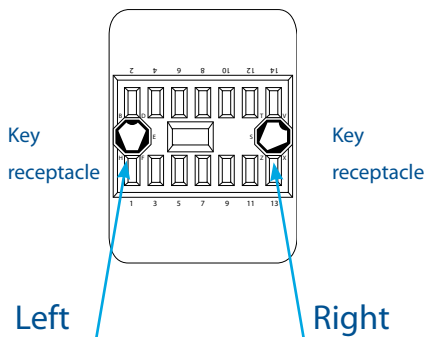

Bottom view relay

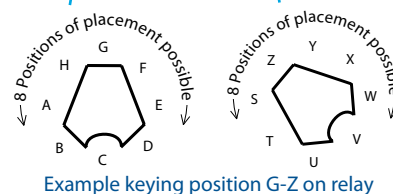
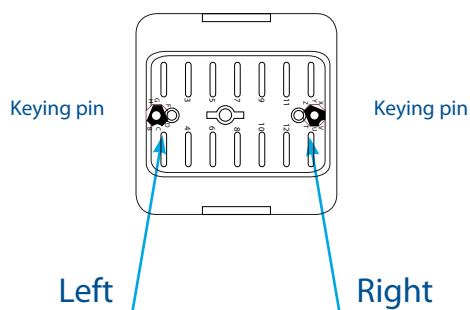

# V29 socket Instructions

## Installation & inspection

### Installation

Before installation or working on the relay: disconnect the power supply first!

Install socket and connect wiring according to the terminal identification. Plug relay into the socket ensuring there is no gap between the bottom of relay and the socket. Reverse installation into the socket is not possible due to the mechanical blocking snap-lock feature.

No external retaining clip needed as the 'snap-lock' will hold the relay into the socket under all circumstances and mounting directions (according shock & vibration requirements IEC 61373, Category I, Class B, Body mounted). If regulations require an external retaining clip, this is available as well. For more information see the datasheet of the retaining clips.

When rail mounting is used, always mount the socket in the direction of the UP arrow.

### Warning!

- To remove relays from the socket, employ up and down lever movements. Sideway movement may cause damage to the coil wires.

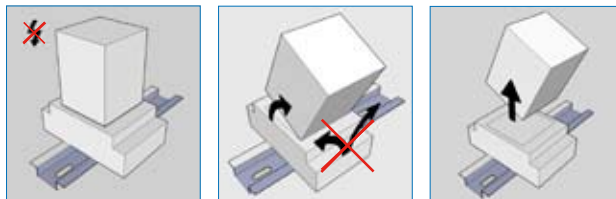

When plugging the relay into the socket, the female trifurcated receivers will automatically cut through the corrosion on the pins and guarantee a reliable connection.

### Inspection

Most defects are caused by installation faults such as overvoltage, spikes/transients, high/short current far exceeding the specifications. When returning products for investigation, please provide all information on the RMA form. Send defective products back to the manufacturer for repair or replacement. Normal wear and tear or external causes are excluded from warranty.



# V29 socket

## Ordering possibilities



V29



V99



A104

Article nr	Code	Description
338000610	V29	Spring clamp terminal relay socket
338003950	V99	Spring clamp terminal relay socket for 8 contact relays
378690100	A104	Key receptacle





[www.morssmitt.com](http://www.morssmitt.com)



Mors Smitt France SAS

Tour Rosny 2, Avenue du Général de Gaulle,  
F - 93118 Rosny-sous-Bois Cedex, FRANCE  
T +33 (0)1 4812 1440, F +33 (0)1 4855 9001  
E [sales@msrelais.com](mailto:sales@msrelais.com)

Mors Smitt Asia Ltd.

# 807, Billion Trade Centre, 31 Hung To Road  
Kwun Tong, Kowloon, HONG KONG SAR  
T +852 2343 5555, F +852 2343 6555  
E [info@morssmitt.hk](mailto:info@morssmitt.hk)

Mors Smitt B.V.

Vrieslantlaan 6, 3526 AA Utrecht,  
NETHERLANDS  
T +31 (0)30 288 1311, F +31 (0)30 289 8816  
E [sales@nieaf-smitt.nl](mailto:sales@nieaf-smitt.nl)

Mors Smitt Technologies Inc.

420 Sackett Point Road  
North Haven, CT 06473, USA  
T +1 (203) 287 8858, F +1 (888) 287 8852  
E [mstechnologies@msrelais.com](mailto:mstechnologies@msrelais.com)

Mors Smitt UK Ltd.

Doulton Road, Cradley Heath  
West Midlands, B64 5QB, UK  
T +44 (0)1384 567 755, F +44 (0)1384 567 710  
E [info@morssmitt.co.uk](mailto:info@morssmitt.co.uk)