

GT3A Series — Analog Timers



Key features of the GT3A series include:

- 4 selectable operation modes on each model
- External start, reset, and pause inputs
- Panel mount or socket mount
- Large variety of timing functions
- Power and output status indicating LEDs



UL, c-uL Listed
File No. E55996



	GT3A-1	GT3A-2	GT3A-3	GT3A-4,-5,-6
Operation	Multi-mode			Multi-mode with inputs (11 pins)
Time Range	0.05s to 180 hours			
Rated Voltage	100 to 240V AC, 50/60Hz 12V DC 24V AC, 50/60Hz / 24V DC			
Contact Ratings	125V AC/250V AC, 3A; 30V DC, 1A (resistive load)		125V AC/250V AC, 5A; 30V DC, 5A (resistive load)	
Minimum Applicable Load	5V, 10mA (reference value)			
Voltage Tolerance	AF20 (100V AC): 85 to 264V AC AD24: 20.4 to 26.4V AC/21.6 to 26.4V DC D12: 10.8 to 13.2V DC			
Error	±0.2%, ±10 msec (repeat, voltage, temperature)			
Setting Error	±10% maximum			
Reset Time	60msec maximum			
Insulation Resistance	100MΩ minimum			
Dielectric Strength	Between power and output terminals: 2,000V AC, 1 minute Between contacts of different poles: 2,000V AC, 1 minute Between contacts of the same pole: 750V AC, 1 minute			
Power Consumption (approximate)	Delayed SPDT	Delayed SPDT + instantaneous SPDT	Delayed DPDT	Delayed DPDT
	10.8VA (200V AC, 60Hz)	13.5VA (200V AC, 60Hz)	14.4VA (200V AC, 60Hz)	4.7VA (100V AC, 60Hz), 14.4VA (200V AC, 60Hz)
	—	12VDC/1W 24VDC/0.7W 24VAC/1.2VA	12VDC/1.1W 24VDC/0.6W 24VAC/1.3VA	12VDC/0.8W 24VDC/0.6W 24VAC/1.3VA
Mechanical Life	10,000,000 operations minimum		5,000,000 operations minimum	
Electrical Life	50,000 operations minimum (rated load)		100,000 operations minimum (rated load)	
Weight (approximate)	63g	73g	79g	80g
Vibration Resistance	100m/sec ² (approximate 10G)			
Shock Resistance	Operating extremes: 100m/sec ² (approximate 10G) Damage limits: 500m/sec ² (approximate 50G)			
Operating Temperature	-10 to +50°C			GT3A Table of Contents Specifications — G-14 Part Number List — G-15 Timing Diagrams/Schematics — G-16 Instructions: Setting Timer — G-22 GT3 Accessories — G-48 GT3 Instructions: Wiring Inputs — G-50 GT3 Dimensions — G-52 Timing Diagrams Overview — G-4
Operating Humidity	45 to 85% RH			
Storage Temperature	-30 to +80°C			
Housing Color	Gray			

Timers

Specifications

Part Number List

Part Numbers: GT3A-1, -2, -3

Mode Of Operation	Rated Voltage Code	Time Range	Output	Contact	Complete Part No.	
					8-Pin	11-Pin
A: ON-delay 1 B: Interval 1 C: Cycle 1 D: Cycle 3	AF20: 100 to 240V AC (50/60Hz)	0.05s. to 180 hours	250V AC, 3A, 30V DC, 1A (resistive load)	Delayed SPDT + Instantaneous SPDT	GT3A-1AF20	GT3A-1EAF20
	AF20: 100 to 240V AC (50/60Hz) D12: 12V DC AD24: 24V AC (50/60Hz)/24V DC				GT3A-2AF20	GT3A-2EAF20
					GT3A-2D12	GT3A-2ED12
			GT3A-2AD24	GT3A-2EAD24		
	240V AC, 5A, 24V DC, 5A (resistive load)		Delayed DPDT	GT3A-3AF20	GT3A-3EAF20	
				GT3A-3D12	GT3A-3ED12	
GT3A-3AD24		GT3A-3EAD24				



1. For wiring schematics and timing diagrams for GT3A-1, -2, -3, see pages G-16, G-17, or G-18 respectively.
2. For more details about time ranges, see instructions on page G-22.
3. For socket and accessory part numbers, see page G-48.

Part Numbers: GT3A-4, -5, -6

Mode of Operation	Rated Voltage Code	Time Range	Output	Contact	Input	Complete Part No.	
						A (11-pin)	B (11-pin)
A: ON-Delay 2 B: Cycle 2 C: Signal ON/OFF-Delay 1 D: Signal OFF-Delay 1	AF20: 100 to 240V AC (50/60Hz) D12: 12V DC AD24: 24V AC (50/60Hz)/24V DC	0.05 seconds to 180 hours	250V AC, 5A, 24V DC, 5A (resistive load)	Delayed DPDT	Start Reset Gate	GT3A-4AF20	GT3A-4EAF20
						GT3A-4D12	GT3A-4ED12
						GT3A-4AD24	GT3A-4EAD24
AF20: 100 to 240V AC (50/60Hz) AD24: 24V AC (50/60Hz)/24V DC	GT3A-5AF20					GT3A-5EAF20	
	GT3A-5AD24					GT3A-5EAD24	
	GT3A-6AF20					GT3A-6EAF20	
A: One-Shot B: One-Shot ON-Delay C: One-Shot 2 D: Signal ON/OFF-Delay 3						GT3A-6AD24	GT3A-6EAD24



4. For wiring schematics and timing diagrams GT3A-4,-5,-6, see pages G-19, G-20, and G-21 respectively.
5. For more details about time ranges, see instructions on page G-22.
6. A (11-pin) and B (11-pin) differ in the way inputs are wired.
7. For socket and accessory part numbers, see page G-48.
8. For the timing diagrams overview, see page G-4.

Timing Diagrams/Schematics

GT3A- 1 Timing Diagrams

Delayed SPDT

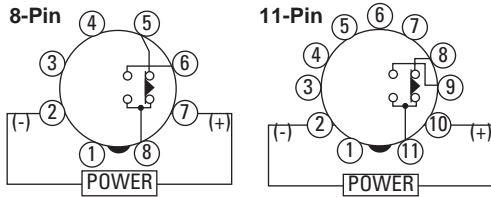

Operation Mode Selection

ON-Delay 1

MODE

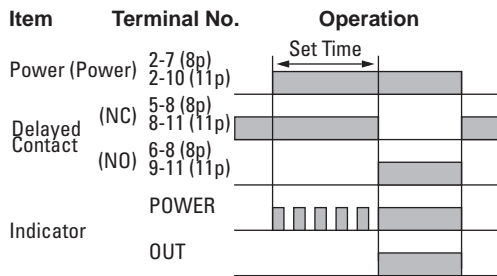

Interval 1

MODE

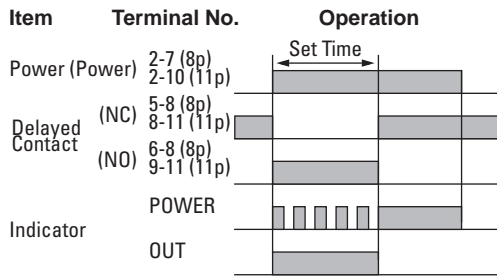

Cycle 1

(OFF first)

MODE

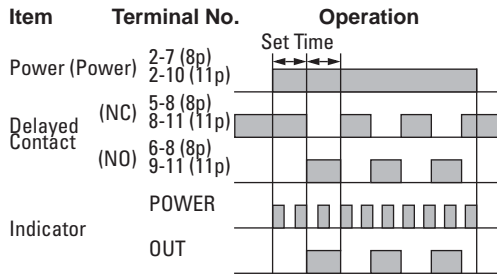

Cycle 3

(ON first)

MODE

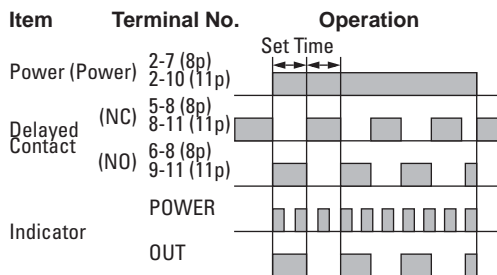

Timers

GT3A- 2 Timing Diagrams

Delayed SPDT + Instantaneous SPDT

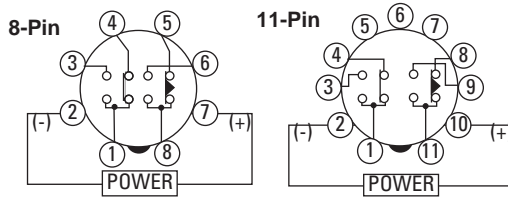

Operation Mode Selection

ON-Delay 1

MODE

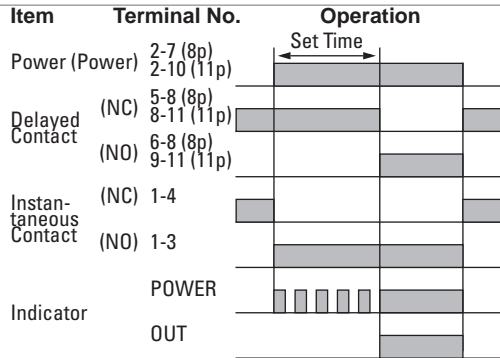

Interval 1

MODE

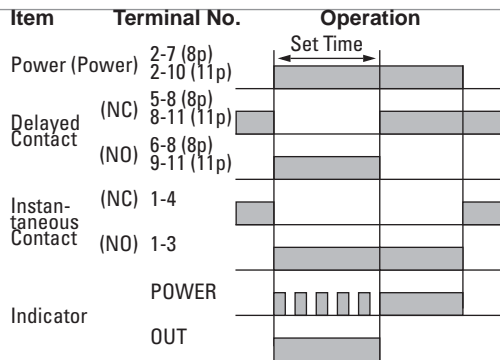

Cycle 1 (OFF first)

MODE

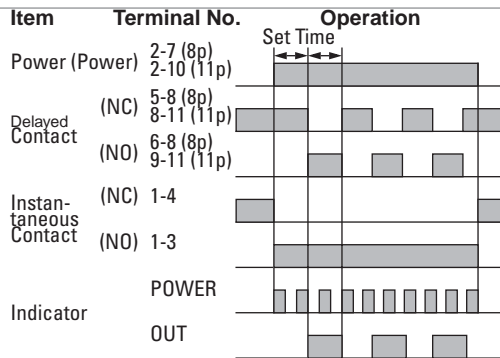

Cycle 3 (ON first)

MODE

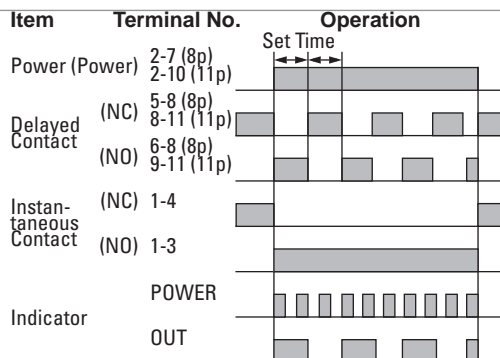

GT3A-3 Timing Diagrams

Delayed DPDT

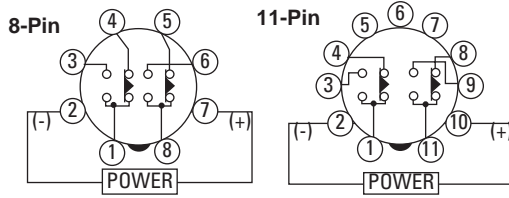

Operation Mode Selection

ON-Delay 1

MODE

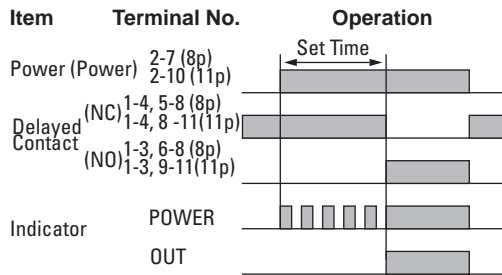

Timers

Interval 1

MODE

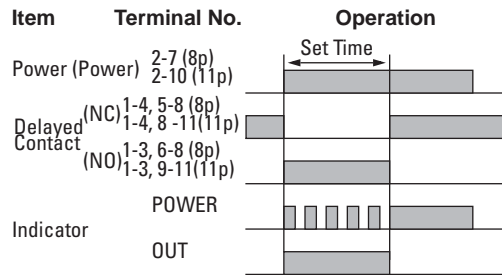

Cycle 1 (OFF first)

MODE

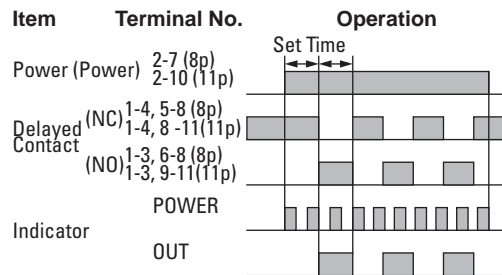

Cycle 3 (ON first)

MODE

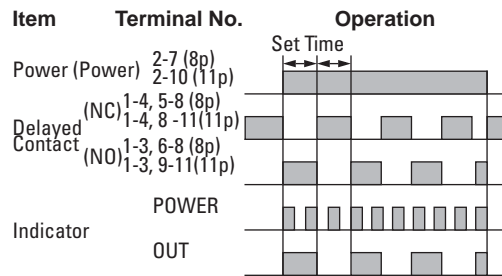

GT3A-4 Timing Diagrams

Delayed DPDT

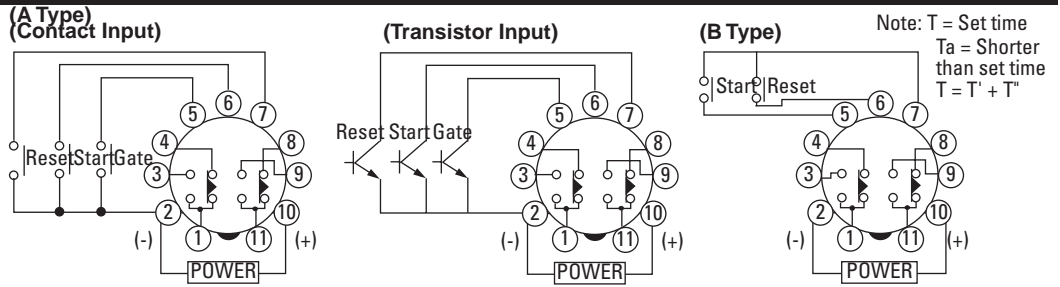

Operation Mode Selection

ON-Delay 2

MODE

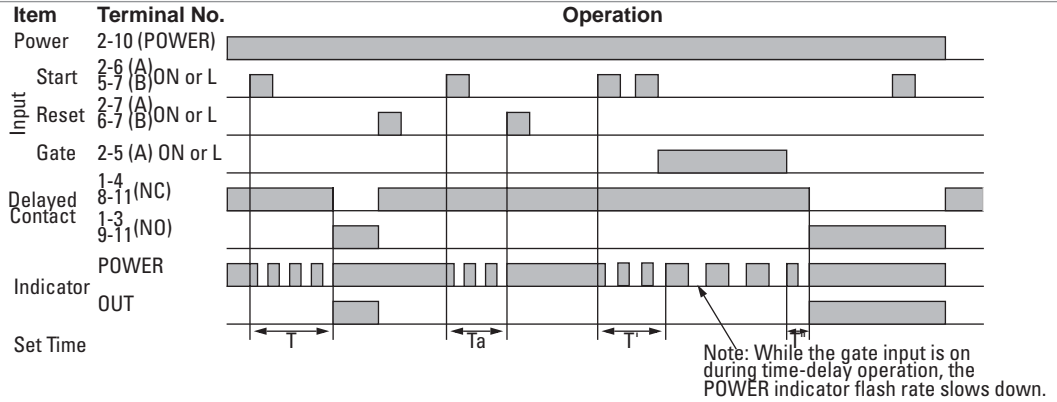

Cycle 2

MODE

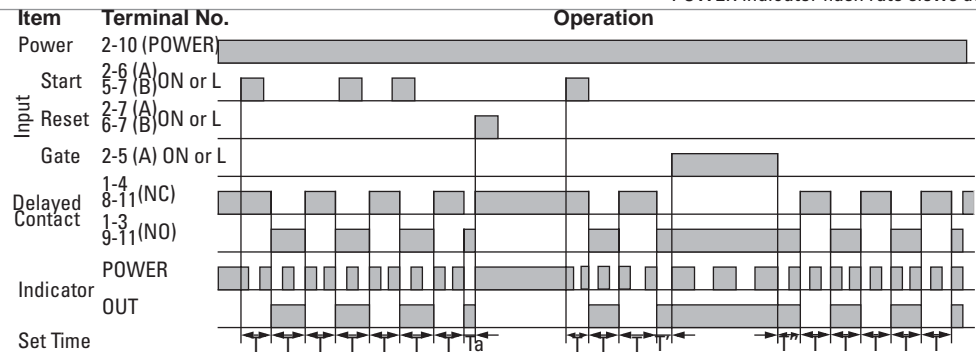

Signal ON/OFF-Delay 1

MODE

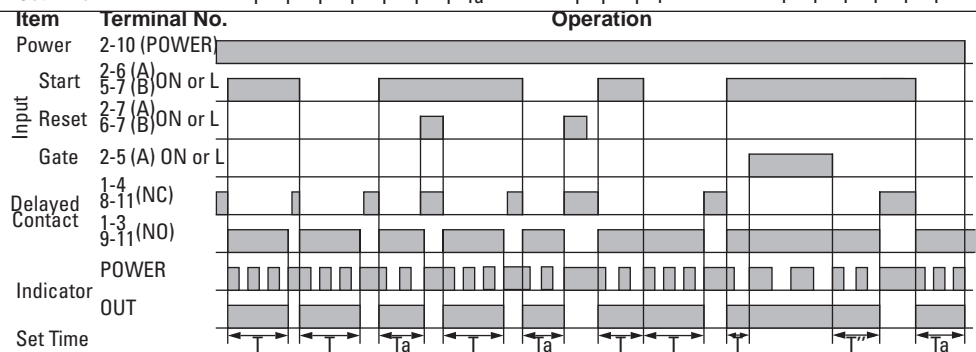

Signal OFF-Delay 1

MODE

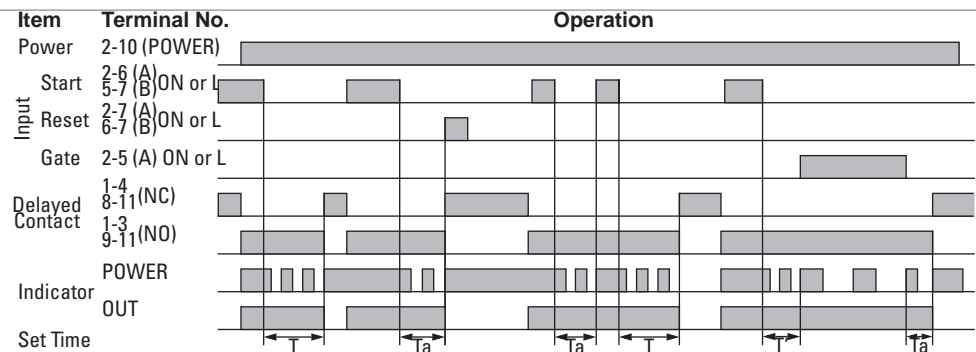

G Timers

GT3A- 5 Timing Diagrams

Delayed DPDT

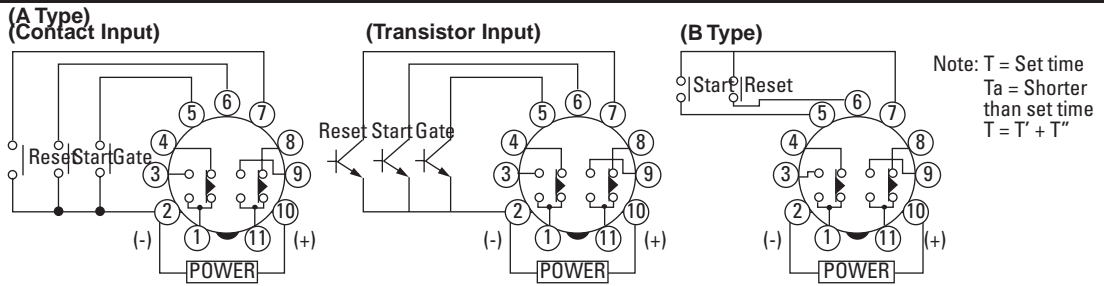

Operation Mode Selection

Interval 2

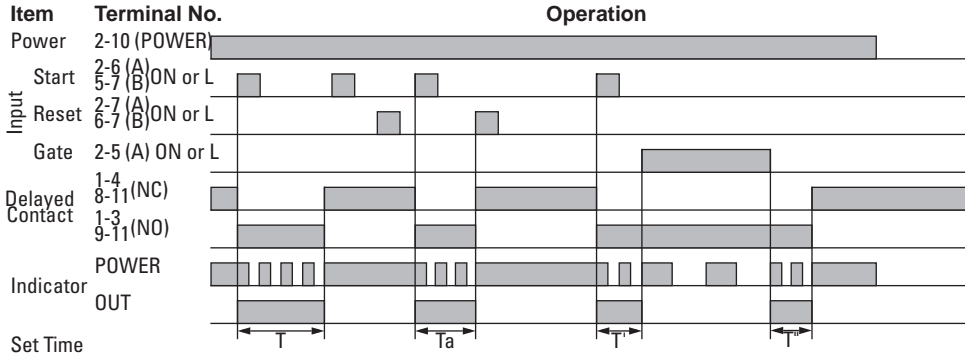

One-Shot Cycle

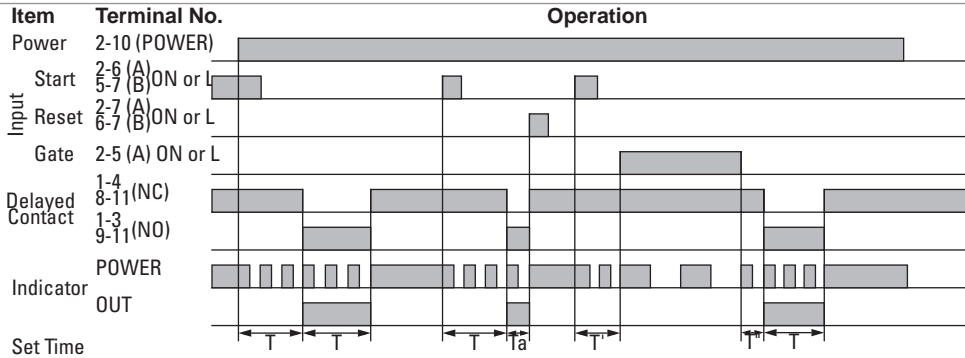

Signal ON/OFF-Delay 2

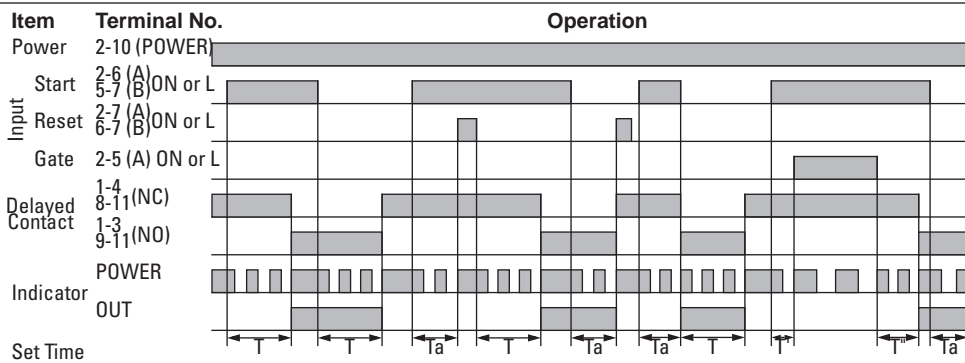

Signal OFF-Delay 2

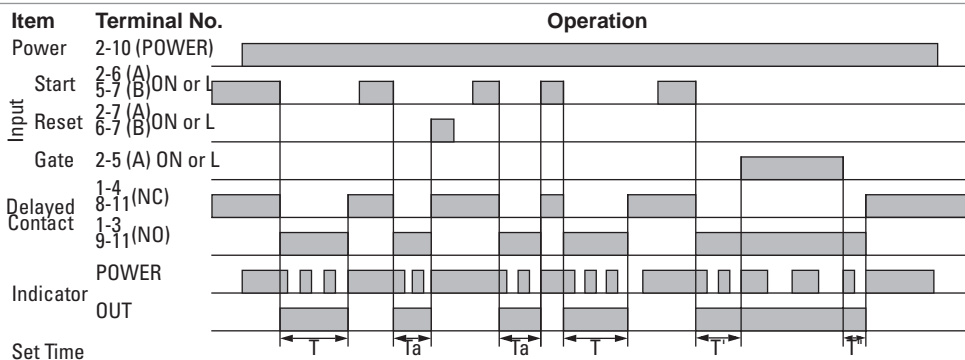

GT3A- 6 Timing Diagrams

Delayed DPDT

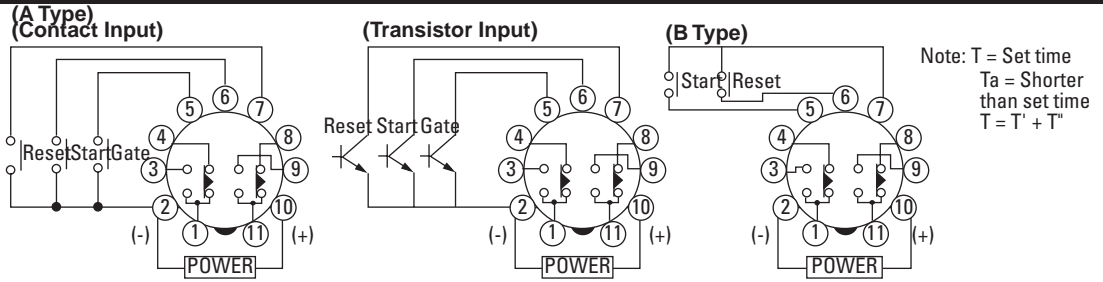

Operation Mode Selection

One-Shot 1

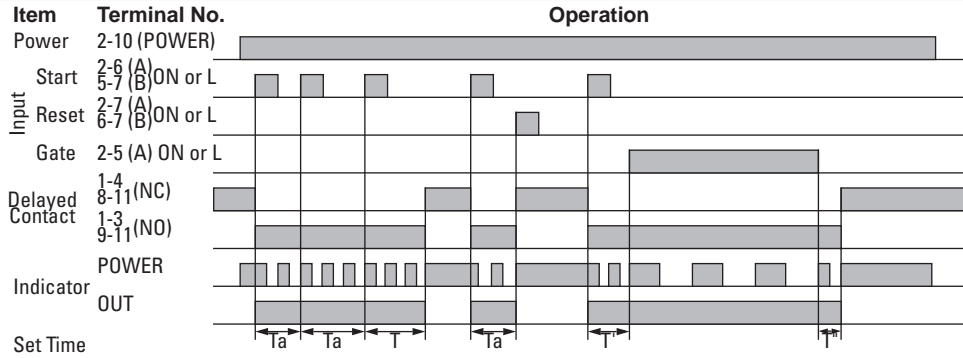

One-Shot ON-Delay

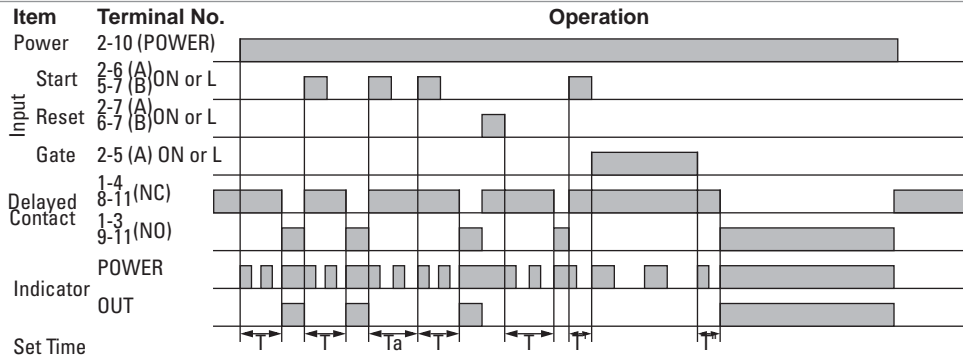

One Shot 2

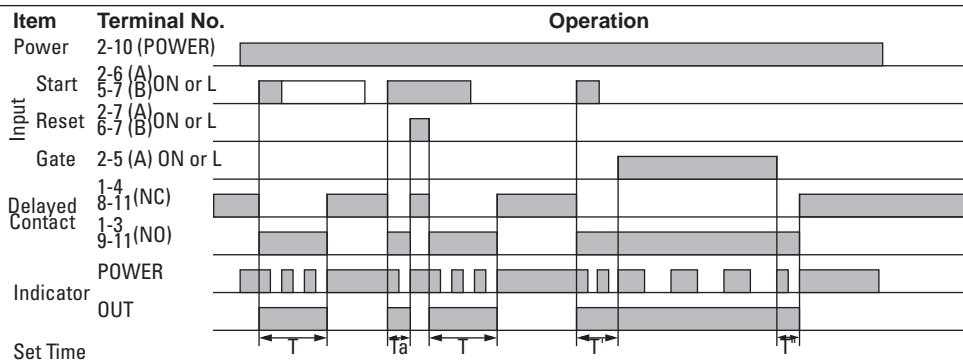

Signal ON/OFF-Delay 3

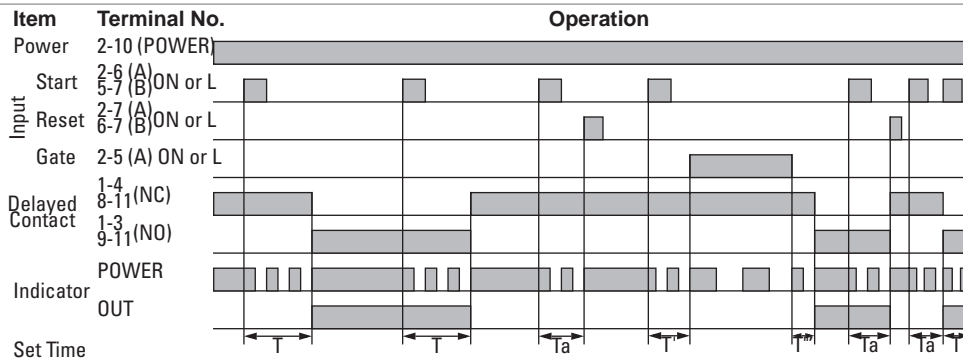

G
Timers

Instructions: Setting GT3A Series Timers

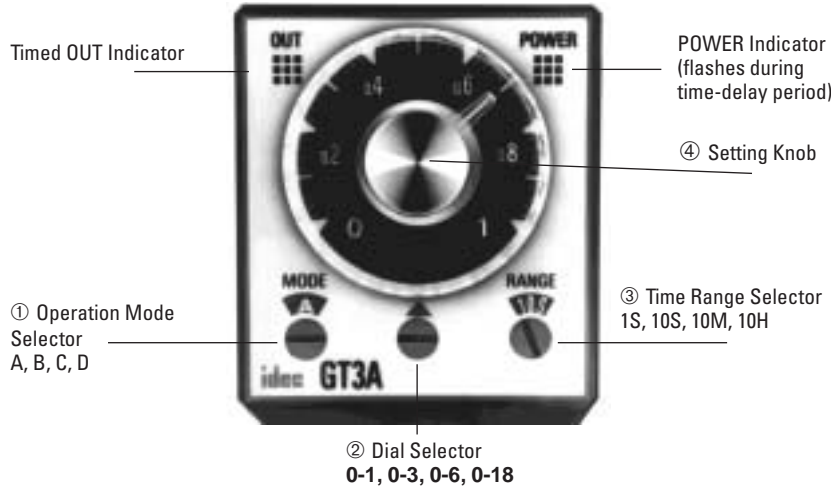

Step 1.	Desired Mode of Operation		Selection	Remarks
<p>Select the desired mode of operation.</p>	For Timers	Mode of Operation	① Operation Mode Selector	<p>The desired operation mode can be selected from the A, B, C, and D modes using the Operation Mode Selector. Change the operation mode from A to B, C, and D in turn by turning the operation mode selector clockwise using a flat screwdriver which is a maximum of 0.156" (4mm) wide. The selected mode is displayed in the window.</p>
		GT3A-1	ON-delay 1	
	GT3A-2	Interval 1	B	
	GT3A-3	Cycle 1	C	
		Cycle 3	D	
	GT3A-4	ON-delay 2	A	
		Cycle 2	B	
		Signal ON/OFF-delay 1	C	
		Signal OFF-delay 1	D	
	GT3A-5	Interval 2	A	
		One-shot cycle	B	
		Signal ON/OFF-delay 2	C	
		Signal OFF-delay 2	D	
GT3A-6	One-shot 1	A		
	One-shot ON-delay	B		
	One-shot 2	C		
	Signal ON/OFF-delay 3	D		

Step 2.	Desired Time Range		Selection		Remarks
<p>Select the time range that contains the desired time period.</p>	Time Ranges		② Dial Selector	③ Time Range Selector	<p>The desired time range is selected by setting both ② Dial Selector and ③ Time Range Selector.</p>
	0.05 seconds to 1 second		0-1	1S	
	0.05 seconds to 3 seconds		0-3		
	0.05 seconds to 6 seconds		0-6		
	0.15 seconds to 18 seconds		0-18		
	0.1 seconds to 10 seconds		0-1	10S	
	0.3 seconds to 30 seconds		0-3		
	0.6 seconds to 60 seconds		0-6		
	1.8 seconds to 180 seconds		0-18		
	6 seconds to 10 minutes		0-1	10M	
	18 seconds to 30 minutes		0-3		
	36 seconds to 60 minutes		0-6		
	108 seconds to 180 minutes		0-18		
	6 minutes to 10 hours		0-1	10H	
	18 minutes to 30 hours		0-3		
	36 minutes to 60 hours		0-6		
108 minutes to 180 hours		0-18			

Step 3.	Selection	
---------	-----------	--

Set the precise period of time desired by using the ④ Setting Knob.

GT3D Series — Digital Timers



Key features of the GT3D series include:

- Precise time setting using digital thumbwheel switches
- Elapsed or time remaining LED display
- 6 time ranges, 16 timing functions
- Time delays up to 99.9 hours



UL Recognized
File No. E55996



CSA Certified
File No. LR58183
LR96764
LR83814



Cert. No.
BL9801133323911 (LVD)
E9971113332388 (EMC)

		GT3D-2	GT3D-3	GT3D-4	GT3D-8	
Specifications	Operation System	Solid state CMOS circuitry				
	Operation	Multi-mode			Multi-mode, one-shot output	
	Time Range	0.01s to 99.9 hours				
	Rated Voltage	100 to 240V AC (50/60Hz), 24V AC (50/60Hz)/24V DC				
	Contact Ratings	125V AC/250V AC, 3A; 30V DC/1A (resistive load)	125V AC/250V AC, 5A; 30V DC/5A (resistive load)			
	Contact Form	Delayed SPDT + instantaneous SPDT	Delayed DPDT	Delayed DPDT	Delayed DPDT	
	Minimum Applicable Load	5V, 10mA (reference value)				
	Voltage Tolerance	AF20 (100–240V AC): 85 to 264V AC AD24 (AC): 20.4 to 26.4V AC AD24 (DC): 21.6 to 26.4V DC				
	Error	±0.3% ±50ms (voltage, repeat, and temperature)				
	Setting Error	±0.5% ±50ms				
	Reset Time	60ms maximum				
	Insulation Resistance	100MΩ minimum				
	Dielectric Strength	Between power and output terminals: 2,000V AC, 1 minute Between contacts of different poles: 2,000V AC, 1 minute Between contacts of the same pole: 750V AC, 1 minute				
	Power Consumption (approximate)	AF20	11.8VA	11.6VA	3.7VA (100V AC, 60Hz) 11.6VA (200V AC, 60Hz)	
		AD24 AC/DC	1VA/0.8W	2.1VA/0.9W	2.1VA /0.9W	
	Mechanical Life	10,000,000 operations minimum		5,000,000 operations minimum		
	Electrical Life (at rated load)	50,000 operations minimum		100,000 operations minimum		
	Outputs	Relay	250V AC, 3A, 30V DC, 1A (resistive load)	240V AC/, 24V DC, 5A (resistive load)		
	Vibration Resistance	100N (approximate 10G)				
Shock Resistance	Operating extremes: 100N (approximate 10G) Damage limits: 500N (approximate 50G)					
Operating Temperature	–10 to +50°C					
Storage Temperature	–30 to +80°C					
Operating Humidity	45 to 85% RH					
Weight (approximate)		70g	75g	76g		
Housing Color	Gray					

GT3D Table of Contents

- Specifications — G-23
- Part Number List — G-24
- Timing Diagrams/ Schematics — G-25
- Instructions:
 - Setting Timer — G-33
- GT3 Accessories — G-48
- GT3 Instructions:
 - Wiring Inputs — G-50
- GT3 Dimensions — G-52
- Timing Diagrams Overview — G-4



Part Number List

Part Numbers: GT3D-1/GT3D-2/GT3D-3

Mode of Operation	Time Range	Output	Contact	Rated Voltage Code	Complete Part No.	
					8-Pin	11-Pin
1-A: ON-delay 1 1-B: Interval 1 first 1-C: Cycle 1 (OFF first) 1-D: Cycle 3 (ON first)	0.01s to 99.9 hours	250V AC, 3A, 30V DC, 1A (resistive load)	Delayed SPDT + instantaneous SPDT	100 to 240V AC (50/60Hz)	GT3D-2AF20	GT3D-2EAF20
				24V AC/DC	GT3D-2AD24	—
		240V AC/ 24V DC, 5A (resistive load)	Delayed DPDT	100 to 240V AC (50/60Hz)	GT3D-3AF20	GT3D-3EAF20
				24V AC/DC	GT3D-3AD24	—

Part Numbers: GT3D-4

Mode of Operation	Time Range	Output	Contact	Rated Voltage Code	Complete Part No.	
					A (11-pin)	B (11-pin)
1-A: ON-delay 1 1-B: Interval 1 first 1-C: Cycle 1 (OFF first) 1-D: Cycle 3 (ON first) 2-A: ON-delay 2 2-B: Cycle 2 2-C: Signal ON/OFF-delay 1 2-D: Signal OFF-delay 1 2-E: Interval 2 2-F: One-shot cycle 3-A: Signal ON/OFF-delay 2 3-B: Signal OFF-delay 2 3-C: One-shot 1 3-D: One-shot ON-delay 3-E: One-shot 2 3-F: Signal ON/OFF-delay 3	0.01s to 99.9 hours	240V AC/24V DC, 5A (resistive load)	Delayed DPDT	100 to 240V AC (50/60Hz)	GT3D-4AF20	GT3D-4EAF20
				24V AC/DC	GT3D-4AD24	—

Part Numbers: GT3D-8

Mode of Operation	Time Range	Output	Contact	Rated Voltage Code	Complete Part No. (11-pin)
1: ON-delay one-shot 1 2: Cycle one-shot 3: ON-delay one-shot 2	0.01s to 99.9 hours	240V AC/24V DC, 5A (resistive load)	Delayed DPDT	100 to 240V AC (50/60Hz)	GT3D-8AF20
				24V AC/DC	GT3D-8AD24

- 
1. For wiring schematics and timing diagrams GT3D, see pages G-25 to G-32.
 2. For more details about time ranges, see instructions on page G-33.
 3. A (11-pin) and B (11-pin) differ in the way inputs are wired.
 4. For socket and accessory part numbers, see page G-48.
 5. For timing diagrams overview, see page G-4.

GT3D-2 Timing Diagrams

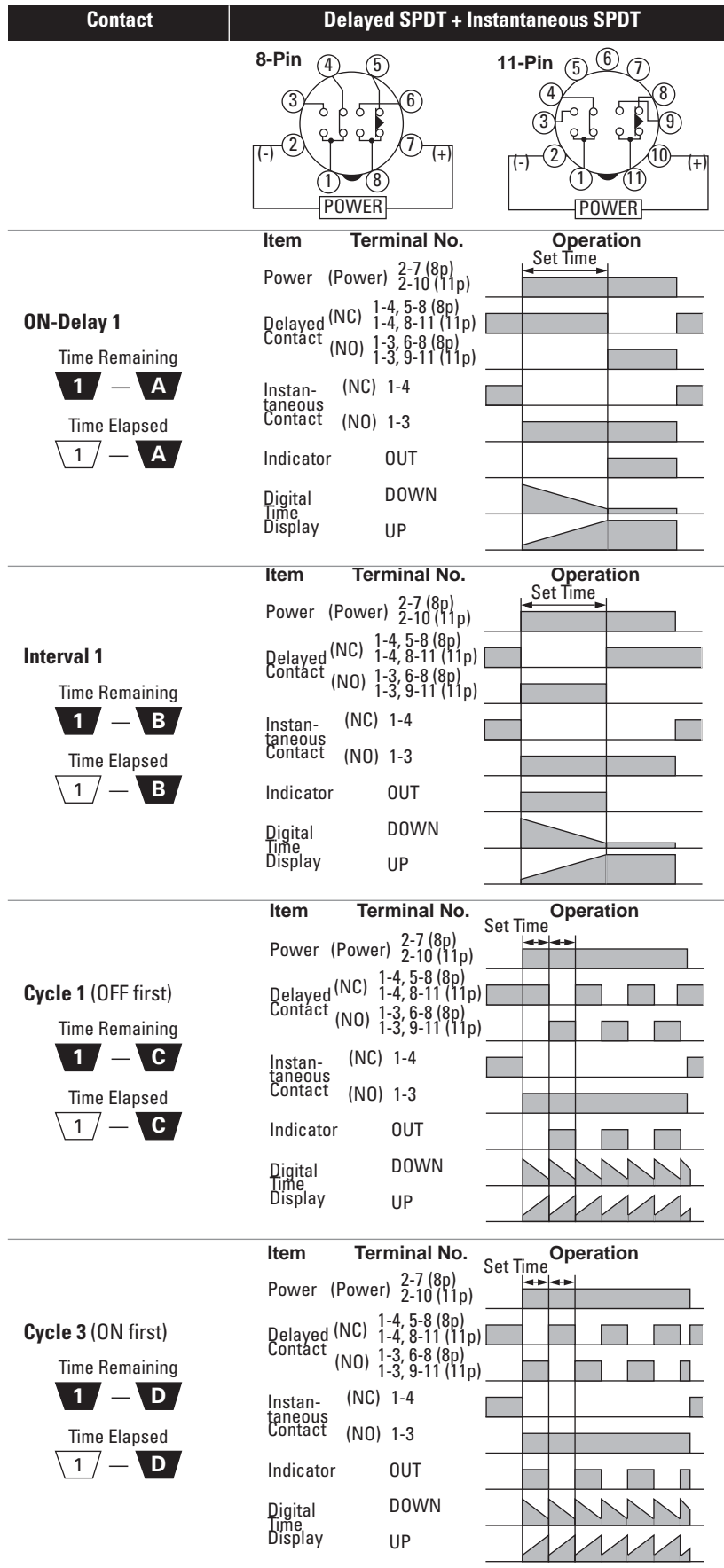

GT3D-3 Timing Diagrams

Contact Delayed DPDT

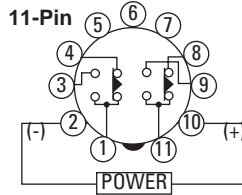
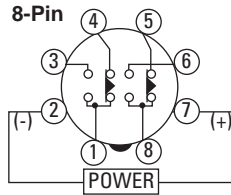

Operation
Mode Selection

ON-Delay 1

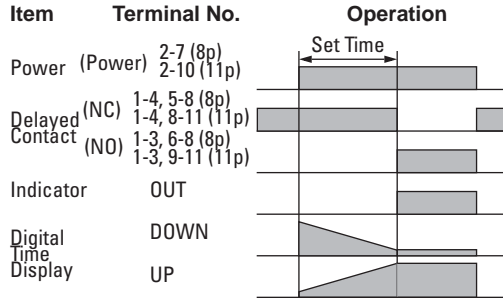

Timers

Interval 1

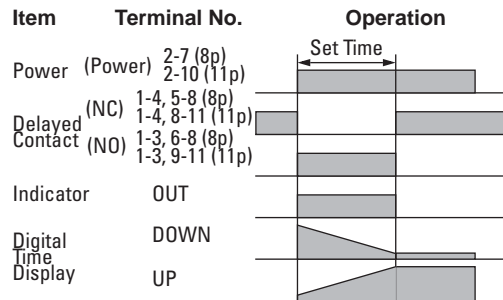

Cycle 1 (OFF first)

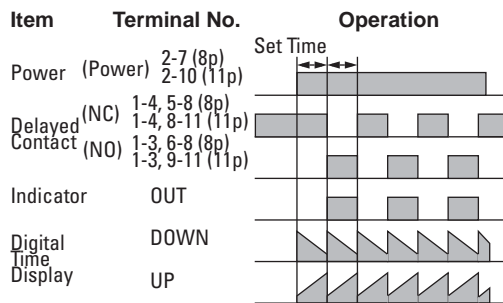

Cycle 3 (ON first)

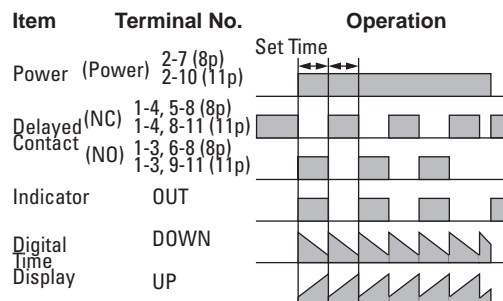

GT3D-4 Timing Diagrams

These timers require a start input. A gate and reset input are optional. Inputs are controlled by external pushbuttons. Reset occurs when the power is removed or when the reset input is supplied. The gate signal can be used to interrupt (freeze) timer functions. Timer functions resume when the gate input is removed. B style timers are not equipped for gate input.

GT3D-4

Delayed DPDT

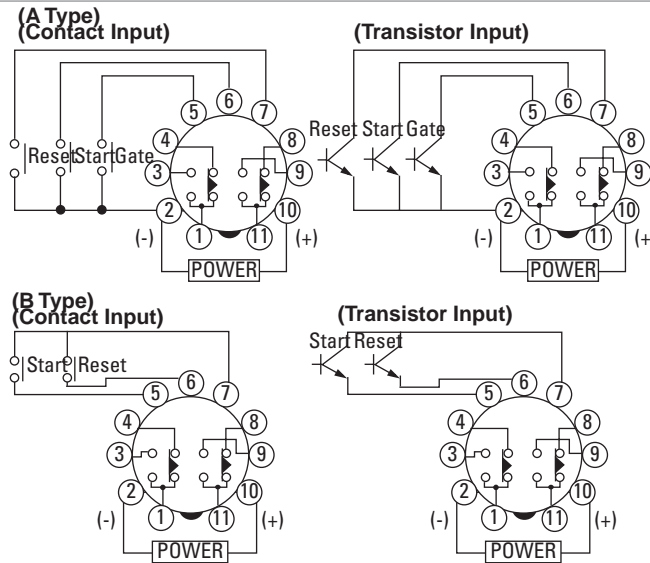

G
Timers

ON-Delay 1

Time Remaining



Time Elapsed

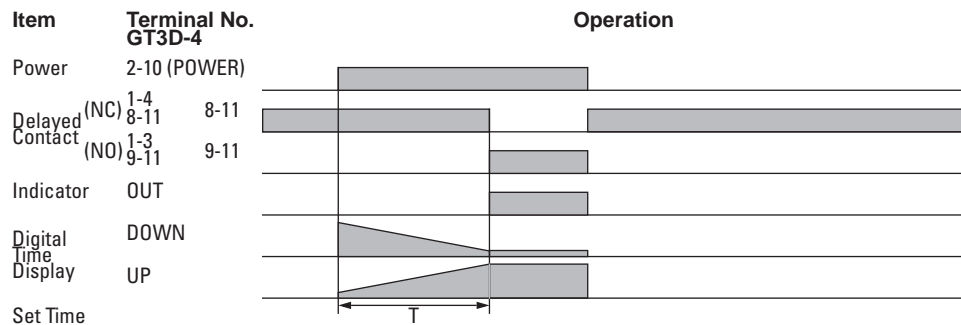
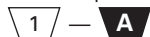

Interval 1

Time Remaining



Time Elapsed

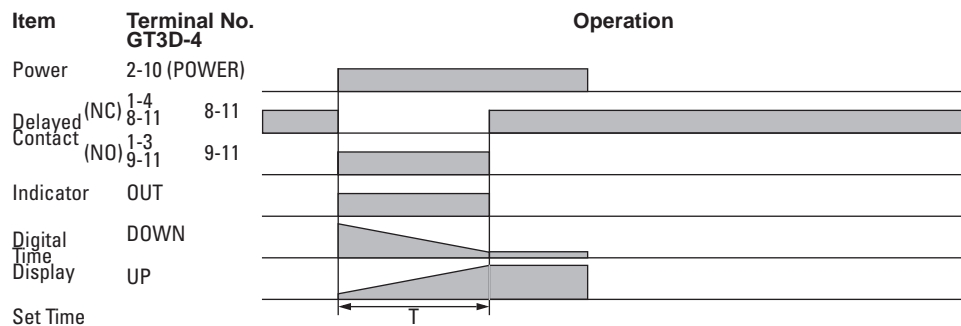
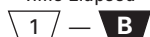

GT3D-4 Timing Diagrams, continued

Cycle 1 (OFF first)
 Time Remaining
1 — **C**
 Time Elapsed
1 — **C**

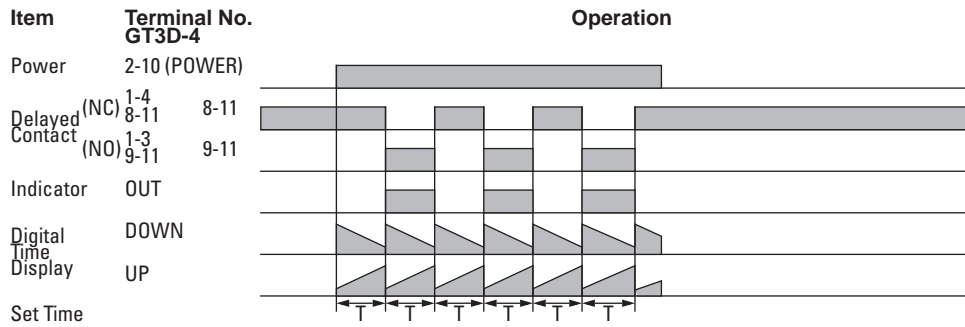

Cycle 3 (ON first)
 Time Remaining
1 — **D**
 Time Elapsed
1 — **D**

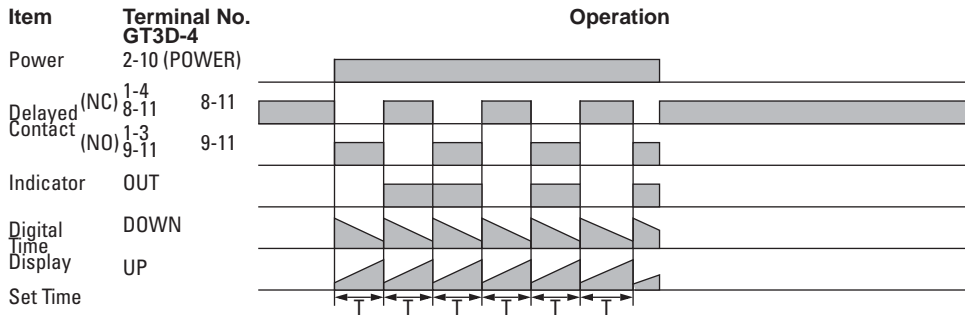

ON-Delay 2
 Time Remaining
2 — **A**
 Time Elapsed
2 — **A**

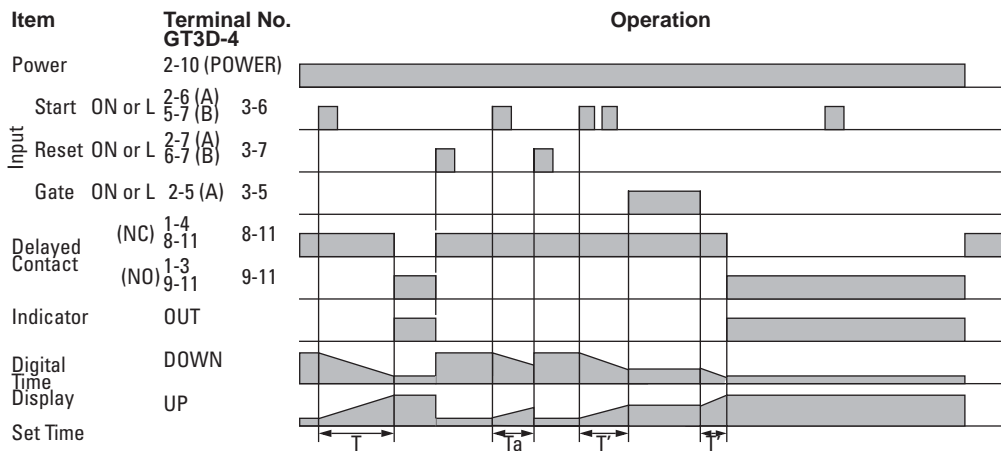

Timers

GT3D-4 Timing Diagrams, continued

Cycle 2

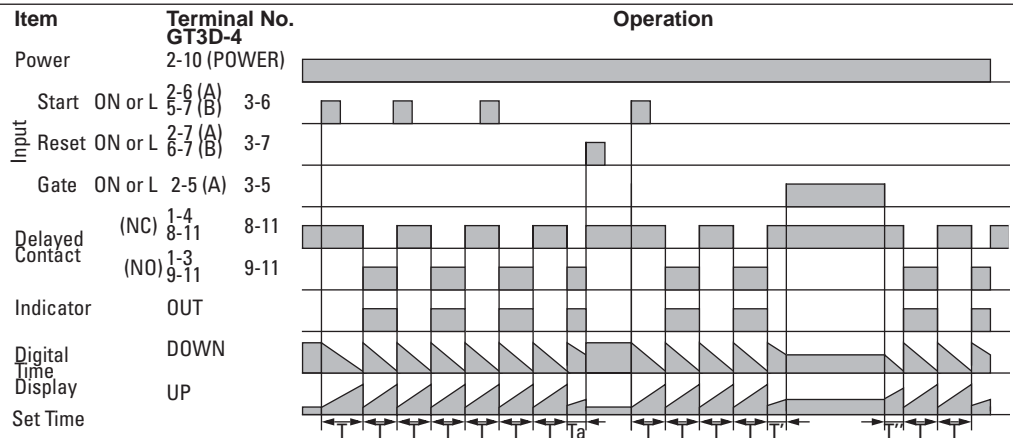
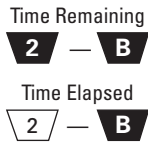

Signal ON/OFF-Delay 1

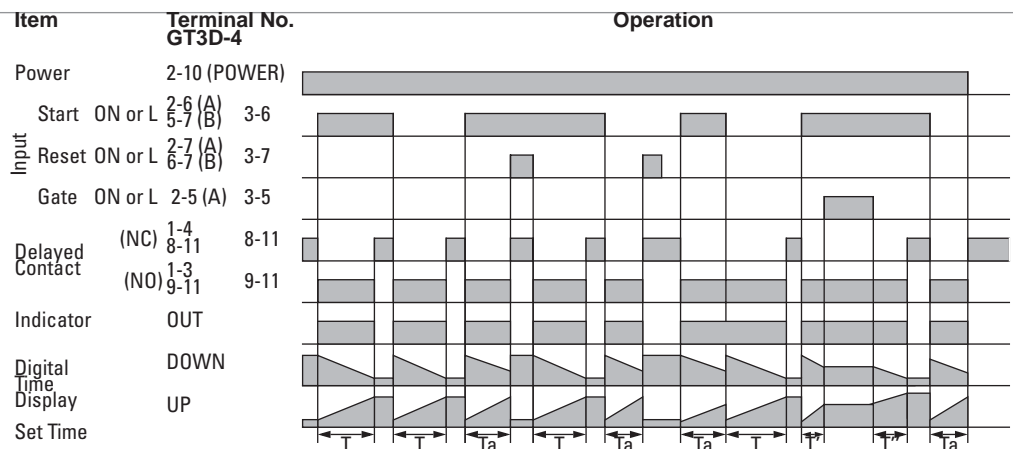
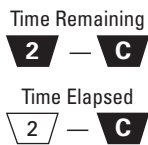

Signal OFF-Delay 1

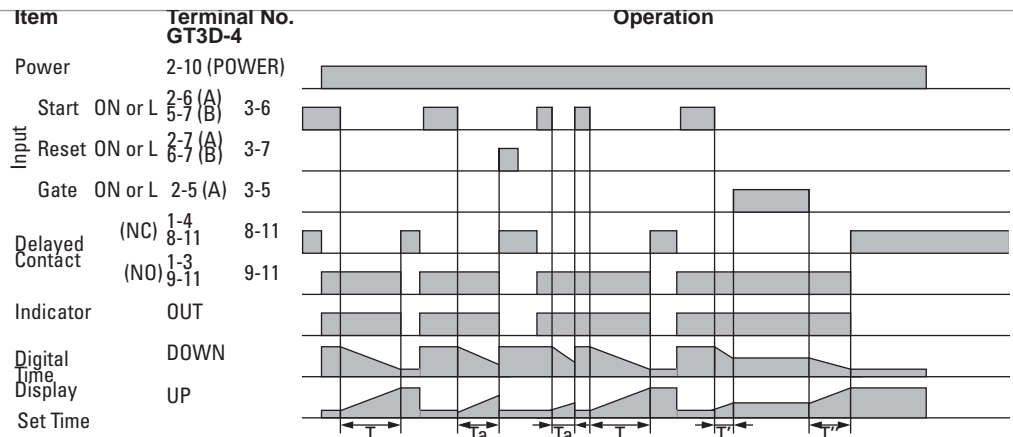
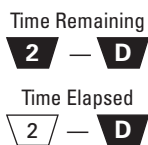

Interval 2

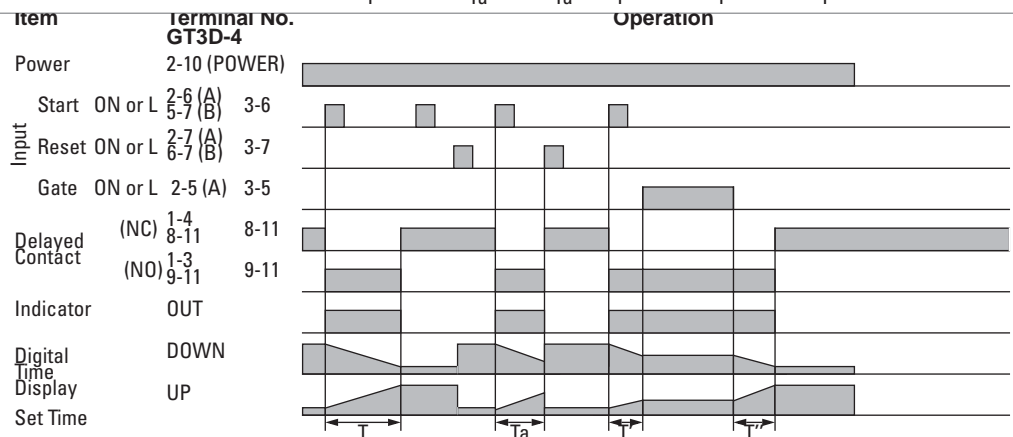
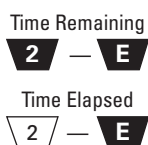

G
Timers

GT3D-4 Timing Diagrams, continued

One-Shot Cycle

Time Remaining

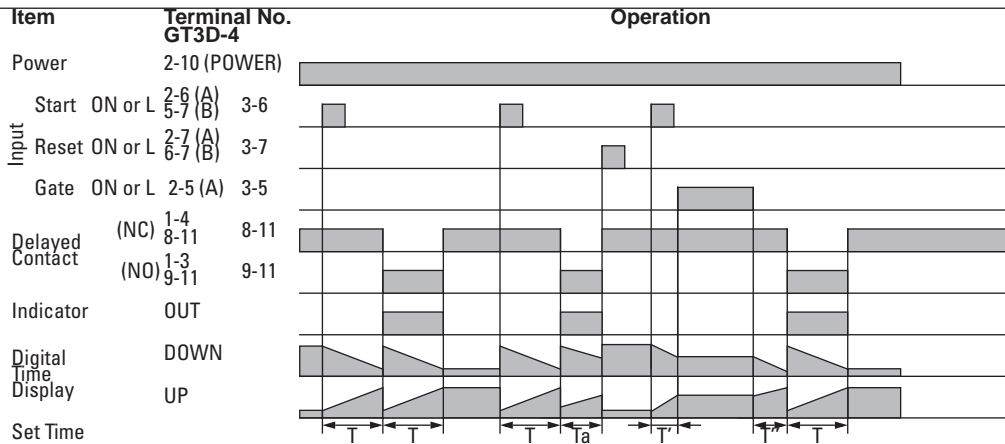

Time Elapsed

Signal ON/OFF-Delay 2

Time Remaining

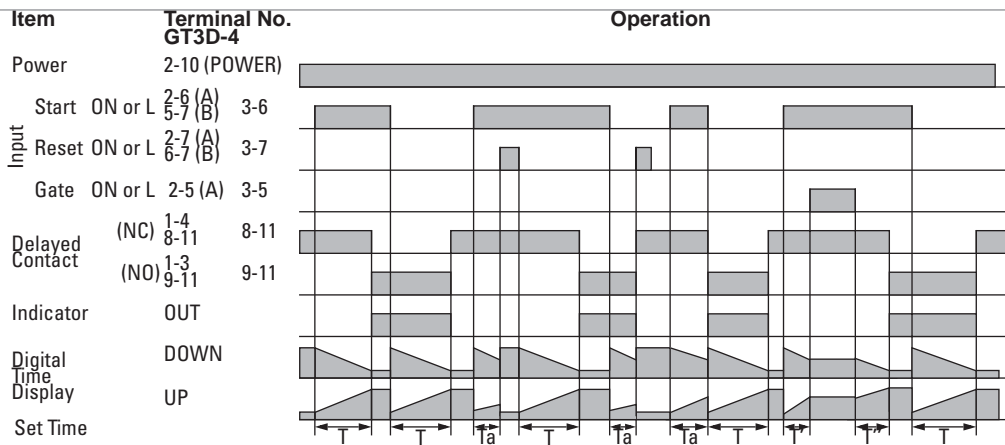

Time Elapsed

Signal OFF-Delay 2

Time Remaining

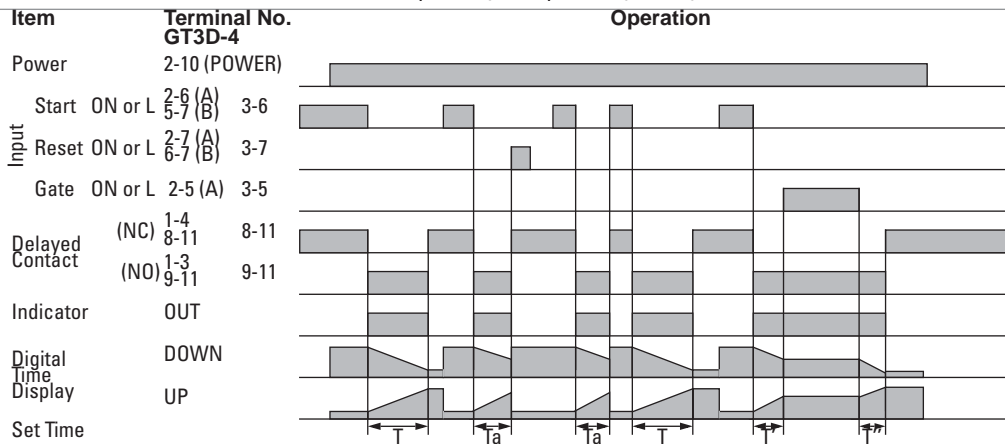

Time Elapsed

One-Shot 1

Time Remaining

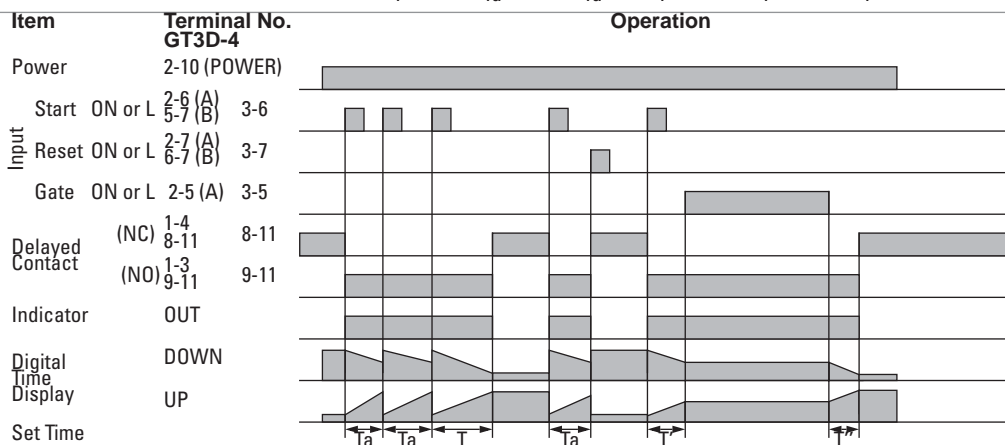

Time Elapsed

Timers

GT3D-4 Timing Diagrams, continued

One-Shot ON-Delay

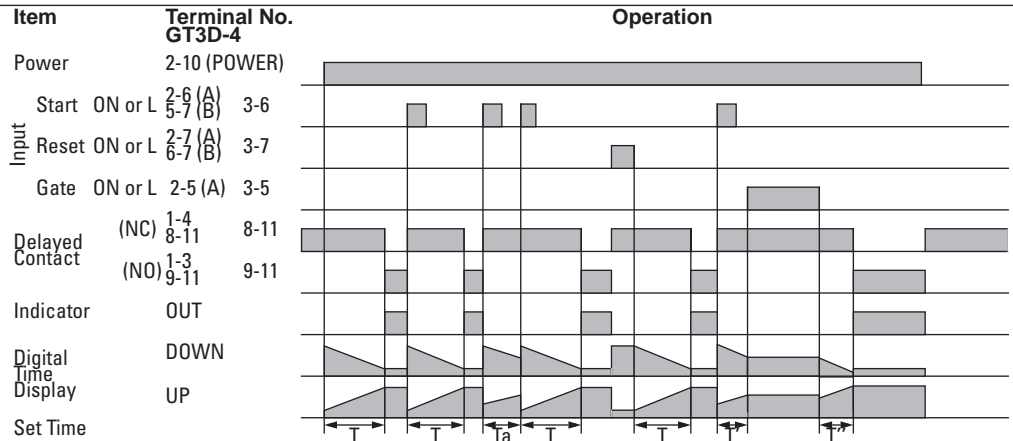
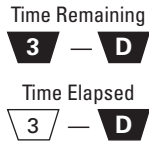

One Shot 2

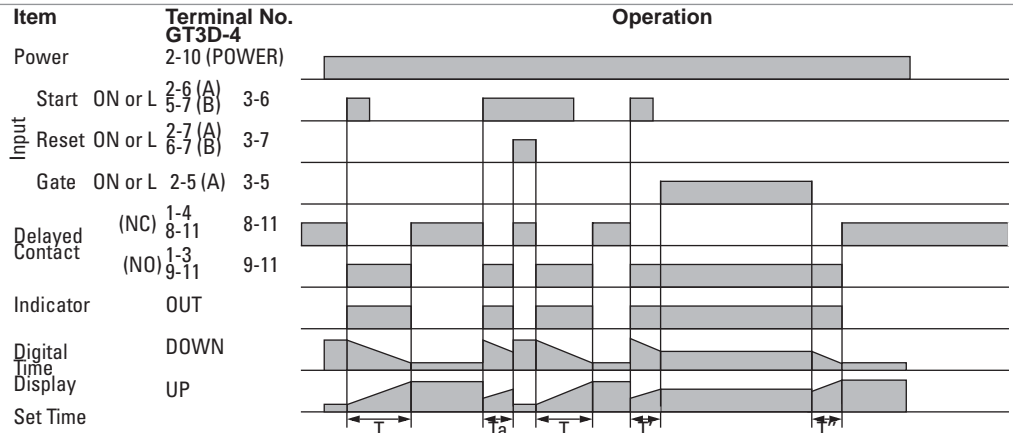
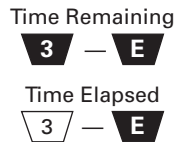

Signal ON/OFF-Delay 3

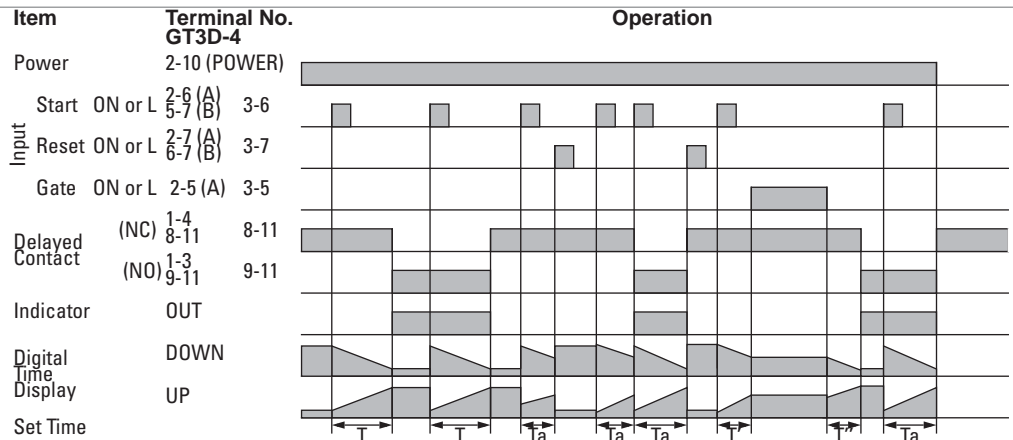
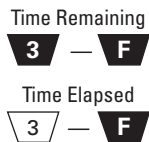

GT3D-8 Timing Diagrams

Delayed DPDT

(Contact Input)

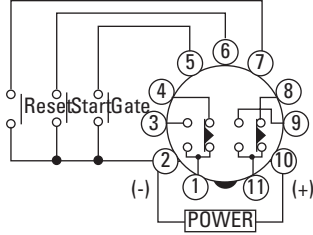

(Transistor Input)

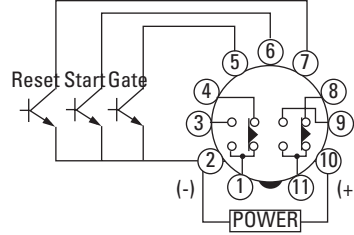

Note: T = Set time
 Ta = Shorter than set time
 Tb = Shorter than single-shot output time
 $T = T' + T''$
 T0 = Single-shot output time (selected from A, B, C, D, E or F)

ON-Delay One-Shot 1

Time Remaining **1**
 Time Elapsed **1**

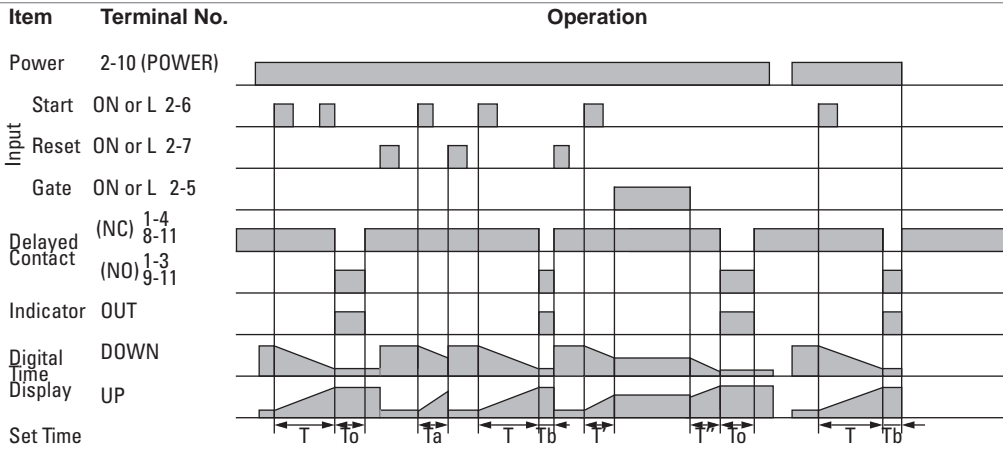

Cycle One-Shot

Time Remaining **2**
 Time Elapsed **2**

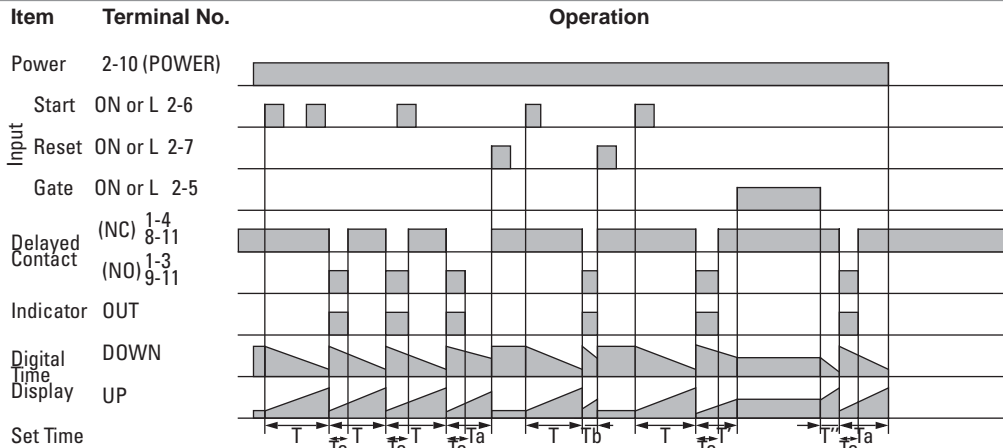

ON-Delay One-Shot 2

Time Remaining **3**
 Time Elapsed **3**

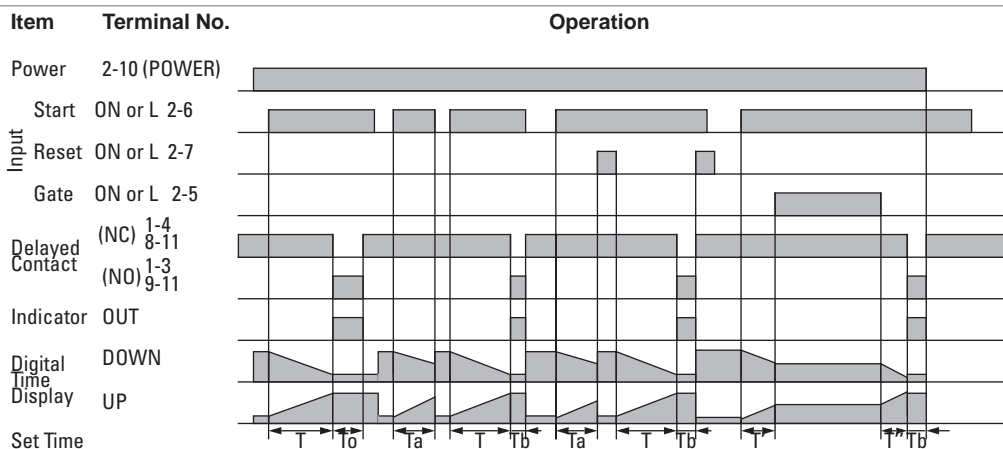

Timers

Instructions: Setting GT3D-2, GT3D-3 Timers

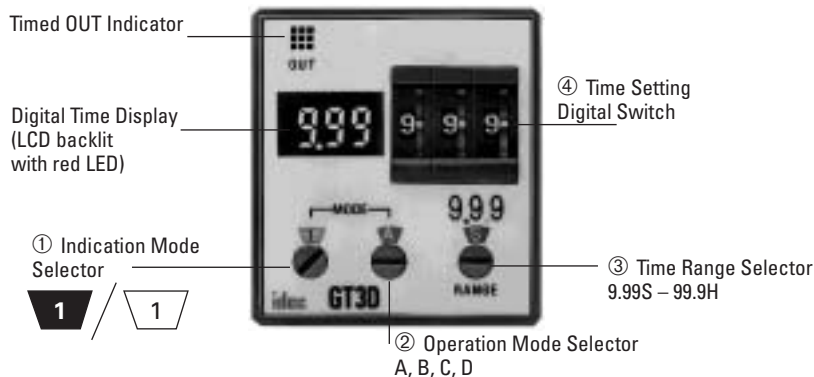

Step 1	Desired Mode/Selection				Remarks
Select the desired time display and operation modes.	Time Display Mode	① Indicator Mode Selector	Operation Mode	② Operation Mode Selector	1. Use the flat screwdriver to set the selectors. Since selectors do not turn all the way around, both clockwise and counterclockwise rotation may be necessary. 2. The ① Indicator Mode Selector determines whether the Digital Time Display shows the time elapsed or time remaining. The ② Operation Mode Selector determines the desired operation mode. Decide which display and mode is desired, then use these two selectors ①② to set the operation mode. 3. The ② Operation Mode Selector has two blank modes which are not intended for use. Always have this selector set to A, B, C, or D.
	Time elapsed	⏏	ON-delay 1	A	
	Time remaining	⏏		A	
	Time elapsed	⏏	Interval	B	
	Time remaining	⏏		B	
	Time elapsed	⏏	Cycle 1	C	
	Time remaining	⏏		C	
	Time elapsed	⏏	Cycle 3	D	
	Time remaining	⏏		D	
Step 2	Desired Operation	Selection		Remarks	
Select a time range that contains the desired period of time.	Base Time Ranges	③ Time Range Selector		1. The ③ Time Range Selector controls both the decimal point indicator (9.99, 99.9, 999) and the time increment indicators S (seconds), M (minutes), and H (hours). 2. Chose which base time range contains the targeted timer setting. Then use the ③ Time Range Selector to set the decimal point indicator and time increment indicator to its corresponding pair of settings. 3. Since these configurations offer a complete range of settings from 0.01 seconds to 99.9 hours, the setting of 9.99 for minutes and the 9.99 and 999 settings for hours are not listed and should not be used.	
		Decimal Point Indicator	Time Increment Indicator		
	0.01 seconds to 9.99 seconds	9.99	S		
	0.1 seconds to 99.9 seconds	99.9			
	1 second to 999 seconds	999			
	0.1 minutes to 99.9 minutes	99.9	M		
	1 minute to 999 minutes	999			
0.1 hours to 99.9 hours	99.9	H			
Step 3	Desired Operation	Selection		Remarks	
Set the precise period of time desired by using the ④ Time Setting Digital Switch.				Use the ④ Time Setting Digital Switch to set the desired period of time. It is important to remember that the setting of the ③ Time Range Selector determines the units of time measurement as well as the implied decimal point location.	



It is important to remember that the ③ Time Range Selector not only selects the time range but also influences the interpretation of the Digital Time Display. Changing the ③ Time Range Selector setting changes the units of time measurement (seconds, minutes, hours) as well as the decimal point location.

Instructions: Setting GT3D-4 Timers

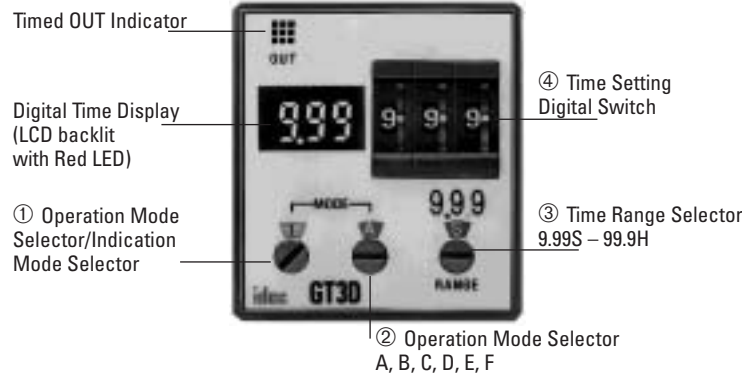

Timers

Step 1	Desired Mode/Selection				Remarks
<p>Select the desired time display and operation modes.</p>	Time Display Mode	① Indicator Mode Selector	Operation Mode	② Operation Mode Selector	<p>1. Use a flat screwdriver to set the selectors. Since selectors do not turn all the way around, both clockwise and counter-clockwise rotation is necessary.</p> <p>2. The ① Indicator Mode Selector determines whether the Digital Time Display shows the time elapsed or time remaining. The ② Operation Mode Selector determines the desired operation mode. Decide which display and mode is desired; then use these two selectors ①② to set the operation mode.</p> <p>3. When using the indicator mode setting "1," the ② Operation Mode Selector has two blank modes which are not intended for use. When using mode setting "1," always have the operation mode selector set to A, B, C, or D.</p>
	Time elapsed	1	ON-delay 1 Interval 1	A B C D	
	Time remaining	1	Cycle 1 D: Cycle 3		
	Time elapsed	2	ON-delay 2 Cycle 2	A B C D E F	
	Time remaining	2	Signal ON/OFF-delay 2 Signal OFF-delay 1 Interval 2 One-shot cycle		
	Time elapsed	3	Signal ON/OFF-delay 2 Signal OFF-delay 2 One-shot 1	A B C D E F	
	Time remaining	3	One-shot ON-delay One-shot 2 Signal ON/OFF-delay 3		
Step 2	Desired Operation	Selection		Remarks	
<p>Select a time range that contains the desired period of time.</p>	Base Time Ranges	③ Time Range Selector		<p>1. The ③ Time Range Selector controls both the decimal point indicator (9.99, 99.9, 999) and the time increment indicator: S (seconds), M (minutes), and H (hours).</p> <p>2. Choose the base time range which contains the targeted timer setting. Then use the ③ Time Range Selector to set the decimal point indicator and time increment indicator to its corresponding pair of settings.</p> <p>3. Since these configurations offer a complete range of settings from 0.01 seconds to 99.9 hours, the setting of 9.99 for minutes and the 9.99 and 999 settings for hours are not listed and should not be used.</p>	
			Decimal Point Indicator		Time Increment Indicator
	0.01 seconds to 9.99 seconds	9.99	S		
	0.1 seconds to 99.9 seconds	99.9			
	1 seconds to 999 seconds	999			
	0.1 minutes to 99.9 minutes	99.9	M		
	1 minute to 999 minutes	999			
0.1 hours to 99.9 hours	99.9	H			
Step 3	Desired Operation	Selection		Remarks	
<p>Select the desired period of time by using the ④ Time Setting Digital Switch.</p>				<p>Use the ④ Time Setting Digital Switch to set the desired period of time. It is important to remember that the setting of the ③ Time Range Selector determines the units of time measurement as well as the implied decimal point location.</p>	



It is important to remember that the ③ Time Range Selector not only selects the time range, but also influences the interpretation of the Digital Time Display. Changing the ③ Time Range Selector setting changes the units of time measurement (seconds, minutes, hours) as well as the implied decimal point location.

Instructions: Setting GT3D-8 Timers

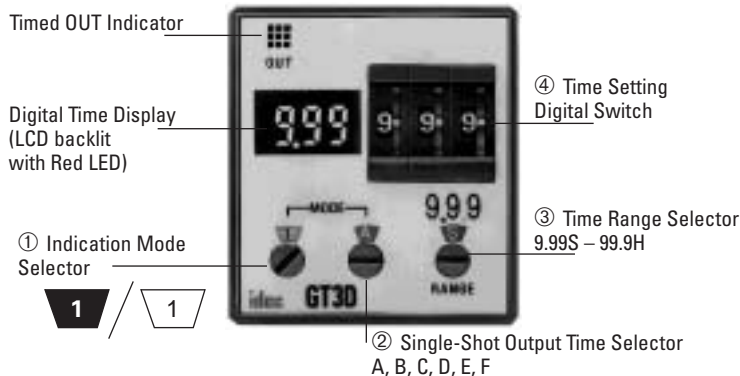

Step 1	Desired Mode of Operation	Selection	Remarks	
Select the time display and operation modes.	Operation Mode	Time Display Mode	① Indicator Mode Selector	
	ON-Delay One-Shot	Time elapsed		
		Time remaining		
	Cycle one-shot	Time elapsed		
		Time remaining		
	ON-delay one-shot 2	Time elapsed		
Time remaining				
Step 2	Desired Mode of Operation	Selection	Remarks	
Select the single shot output time.	Desired Single-Shot Output Time	② Single-Shot Output Time Selector	On the GT3D-8 timers, the desired single-shot output time can be selected from the A, B, C, D, E, and F modes using the ② One-Shot Output Time Selector.	
	0.1 seconds	A		
	0.5 seconds	B		
	1 second	C		
	5 seconds	D		
	10 seconds	E		
	50 seconds	F		
Step 3	Desired Mode of Operation	Selection	Remarks	
Select the time range that contains the desired period of time.	Base Time Ranges	③ Time Range Selector	1. The ③ Time Range Selector controls both the decimal point indicator (9.99, 99.9, 999) and the time increment indicator: S (seconds), M (minutes), and H (hours). 2. Chose which base time range contains the targeted timer setting. Then use the ③ Time Range Selector to set the decimal point indicator and time increment indicator to its corresponding pair of settings. 3. Since these configurations offer a complete range of settings from 0.01s to 99.9 hours, the setting of 9.99 for minutes and the 9.99 and 999 settings for hours are not listed and should not be used.	
	0.01 seconds to 9.99 seconds	9.99		
	0.1 seconds to 99.9 seconds	99.9		
	1 second to 999 seconds	999		
	0.1 minutes to 99.9 minutes	99.9		
	1 minute to 999 minutes	999		
0.1 hours to 99.9 hours	99.9			
Step 4	Desired Mode of Operation	Selection	Remarks	
Select the desired period of time by using the ④ Time Setting Digital Switch.			Use the ④ Time Setting Digital Switch to set the desired period of time. It is important to remember that the setting of the ③ Time Range Selector selects the units of time measurement as well as the implied decimal point location.	

G Timers



It is important to remember that the ③ Time Range Selector not only selects the time range, but also influences the interpretation of the Digital Time Display. Changing the ③ Time Range Selector setting changes the units of time measurement (seconds, minutes, hours) as well as the decimal point location.

GT3F Series — True OFF Delay Timers



Key features of the GT3F series include:

- Mountable in sockets or flush panel
- “True” power OFF-delay up to 10 minutes
- No external control switch necessary
- Available with reset inputs



UL, c-UL Listed
File No. E55996



	GT3F-1	GT3F-2
Operation	True power OFF-delay	
Time Range	0.05 seconds to 600 seconds	
Rated Voltage	100 to 240V AC, 50/60Hz 24V AC/DC	
Contact Rating	250V AC/30V DC, 5A (resistive load)	250V AC/30V DC, 3A (resistive load)
Contact Form	SPDT	DPDT
Minimum Power Application Time	1 second	
Voltage Tolerance	AF20: 100 to 240V AC AD24: 21.6 to 26.4VDC, 20.4 to 26.4VAC	
Repeat Error	±0.2%, ±10 msec	
Voltage Error	±0.2%, ±10 msec	
Temperature Error	±0.2%, ±10 msec	
Setting Error	±10% maximum	
Insulation Resistance	100MΩ minimum	
Dielectric Strength	Between power and output terminals: 2,000V AC, 1 minute (SPDT) 1,500V AC, 1 minute (DPDT) Between contacts on different poles: 1,000V AC, 1 minute (DPDT) Between contacts of the same pole: 750V AC, 1 minute	
Power Consumption	AF20: 3.7VA (200V AC, 60Hz) AD24: 0.8W (DC), 1.2VA (AC)	
Mechanical Life	20,000,000 operations minimum	
Electrical Life	100,000 operations minimum	
Vibration Resistance	100m/sec ² (approximate 10G)	
Shock Resistance	Operating extremes: 100 m/sec ² (approximate 10G) Damage limits: 500 m/sec ² (approximate 50G)	
Operating Temperature	-10 to +50°C	
Storage Temperature	-30 to +80°C	
Operating Humidity	45 to 85% RH	
Weight (approximate)	77g	79g

GT3F Table of Contents

Specifications — G-36
Part Number List — G-37
Timing Diagrams/Schematics — G-37
Instructions: Setting Timer — G-39
Instructions: Wiring Inputs — G-40
GT3 Accessories — G-48
GT3 Instructions — G-50
GT3 Dimensions — G-52
Timing Diagrams Overview — G-4



1. An inrush current flows during the minimum power application time. AF20: approximate 0.3A, AD24: approximate 0.6A
2. GT3F does not read the preset time range shown on the knob after power is turned off. Note that minimizing the preset time, by turning the knob to zero, does not shorten the delay time after power is removed.

Part Numbering List

Part Numbers: GT3F

Mode of Operation	Rated Voltage Code	Time Range	Output	Contact	Optional Input	Complete Part Number	
						8-Pin	11-Pin
Power OFF-delay	AF20: 100 to 240VAC (50/60Hz)	0.05 seconds to 600 seconds	250V AC, 5A, 30V DC, 5A (resistive load)	Delayed SPDT	Reset	GT3F-1AF20	GT3F-1EAF20
						GT3F-1AD24	GT3F-1EAD24
	AD24: 24V AC/DC		250V AC, 3A, 30V DC, 3A (resistive load)	Delayed DPDT	None (8p) Reset (11p)	GT3F-2AF20	GT3F-2EAF20
						GT3F-2AD24	GT3F-2EAD24



1. Optional reset input resets the contact to the OFF state before time out.

Timing Diagrams/Schematics

GT3F-1 Timing Diagrams

GT3F-1 (8-pin)

GT3F-1E (11-pin)

Delayed SPDT Output, with Reset Input

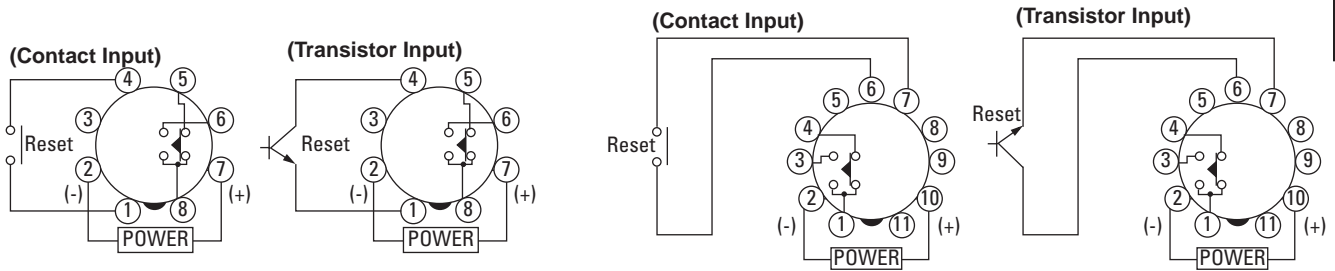

G Timers

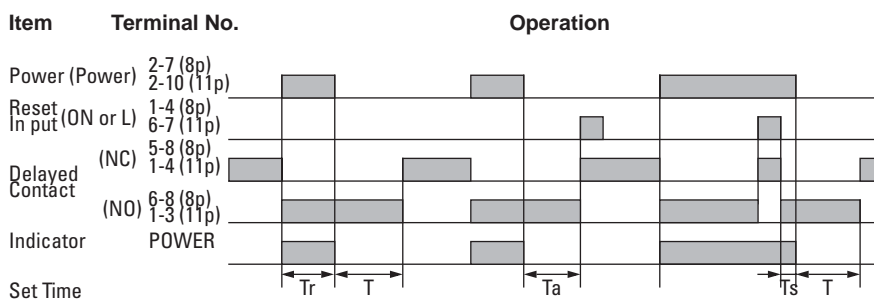

T = Set Time
 Ta = Shorter than Set Time
 Ts = 1 Second
 Tr = Minimum Power Application Time
 • GT3F-1: 1 Second



- For time ranges, see page G-39.
- For sockets and accessory part numbers, see page G-48.
- When power is applied, the NO output contact closes. When power is removed, the timing period begins. When time has elapsed, the NO contact opens.
- For the timing diagram overview, see page G-4.

GT3F-2 Timing Diagrams

GT3F-2 (8-pin)

GT3F-2E (11-pin)

Delayed DPDT Output

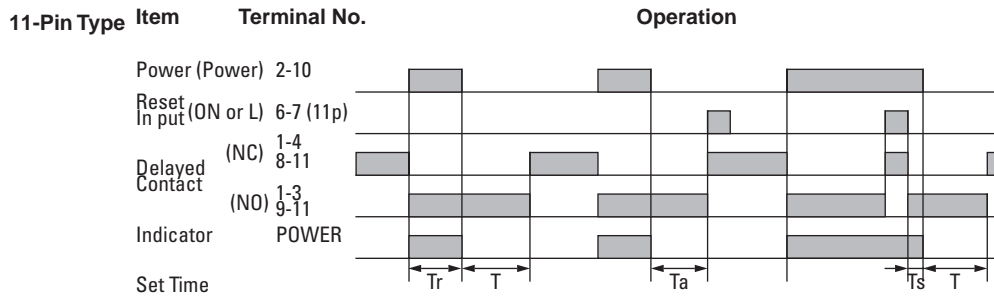
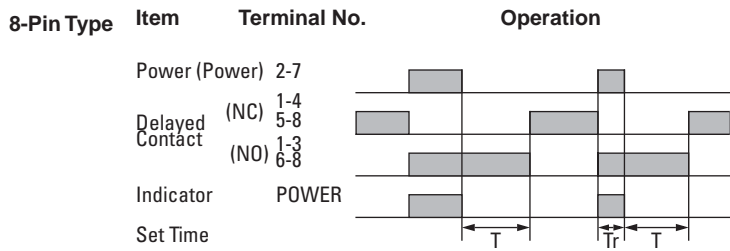
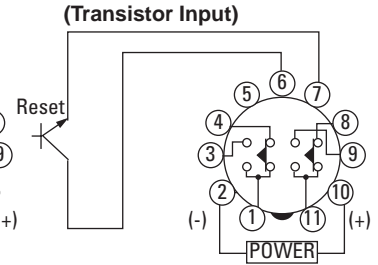
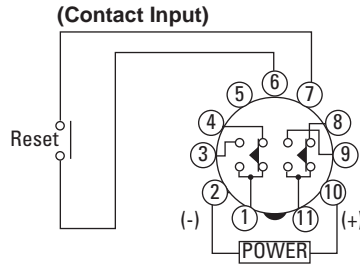
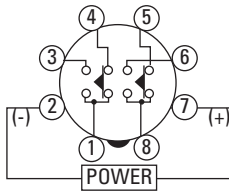

When power is applied, the NO contact closes. When power is removed, the timing period begins. When time has elapsed, the NO contact opens. Optional reset input will return contacts to original state before time elapses.

Instructions: Setting GT3F Timers

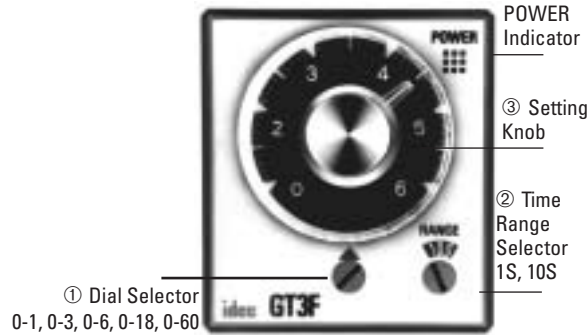

Steps	Desired Operation	Selection		Remarks
1. Select a time range that contains the desired period of time.	Base Time Ranges	① Dial Selector	② Time Range Selector	Time range can be selected from 1S and 10S using a flat screwdriver and five different dials of 0 to 1, 0 to 3, 0 to 6, 0 to 18, and 0 to 60 are displayed in the six windows by turning the Dial Selector, allowing for selecting the best suited scale. Note that the switch does not turn infinitely.
	0.05s to 1s	0 to 1	1S	
	0.05s to 3s	0 to 3		
	0.05s to 6s	0 to 6		
	0.1s to 10s	0 to 1	10S	
	0.3s to 30	0 to 3		
	0.6s to 60	0 to 6		
	1.8s to 180s	0 to 18		
6s to 600s	0 to 60			
2. The set time is selected by turning the ③ Setting Knob.				Setting Examples: 1) When the Setting Knob ③ is set at 2.5, with Dial Selector ① 0 to 3 and Time Range Selector ② 1S selected, then the set time is 2.5 seconds. 2) When the Setting Knob ③ is set at 5.0, with Dial Selector ① 0 to 60 and Time Range Selector ② 10S selected, then the set time is 500 seconds.

Instructions: Wiring Inputs

Inputs of GT3F

To avoid electric shock, do not touch the input signal terminal during power voltage application. Never apply the input signals to two or more GT3F timers using the same contact or transistor.

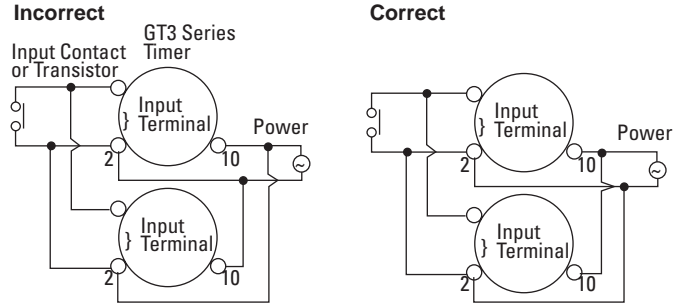

In a transistor circuit for controlling input signals, with its primary and secondary power circuits isolated, do not ground the secondary circuit.

Timers

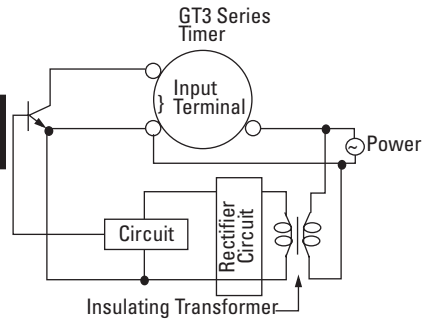

On the GT3F timers, connect the input signals to terminal No.1 and 4 only on the 8-pin type; connect the input signals to terminal No. 6 and 7 only on the 11-pin type. Never apply voltage to other terminals; otherwise, the internal circuit may be damaged.

Input signal lines must be made as short as possible and installed away from power cables and power lines. Use shielded wires or a separate conduit for input wiring.

The GT3F, consisting of a high-impedance circuit, may not be reset due to the influence of an inductive voltage or residual voltage caused by a leakage current. If not reset, connect an RC filter or bleeder resistor between power terminals so that the voltage between power terminals can be reduced to less than 15% of the rated voltage.

GT3 (Star-Delta) Timers

Star-Delta

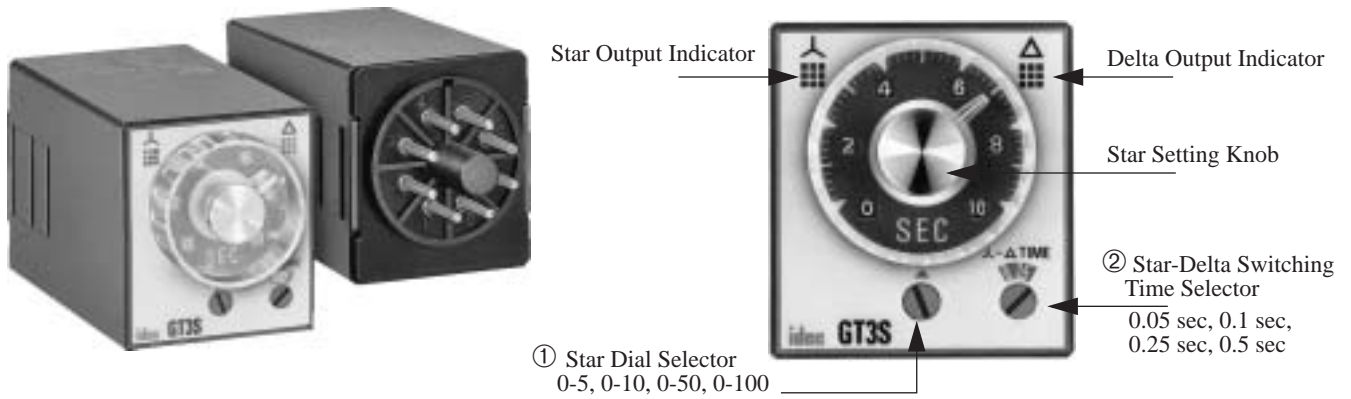

Operation Mode	Rated Input Voltage	Time Range	Output	Contact	Part No.
					8-pin Type
Star-Delta	AF20: 100 to 240V AC (50/60Hz)	Star: 0.05 to 100 sec Star-Delta switching time: 0.05 sec 0.1 sec 0.25 sec 0.5 sec	250V AC/30V DC, 5A (resistive load)	Star: Delayed SPST-NO Delta: Delayed SPST-NO	GT3S-1AF20
				Star: Delayed SPST-NO Delta: Delayed SPST-NO Instantaneous: SPST-NO	GT3S-2AF20

Time Ranges:

① Star Dial Selector		② Star-Delta Switching Time Selector
Dial	Time Range	Time
0-5	0.05 sec - 5 sec	0.05 sec
0-10	0.1 sec - 10 sec	0.1 sec
0-50	0.5 sec - 50 sec	0.25 sec
0-100	1 sec - 100 sec	0.5 sec

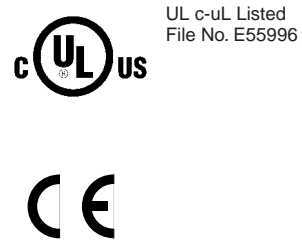

Contact Ratings:

Contact Ratings		250V AC/30V DC, 5A (resistive load)
Life	Mechanical	20,000,000 operations minimum
	Electrical	100,000 operations minimum (rated load)











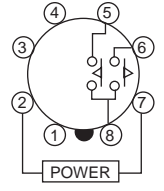
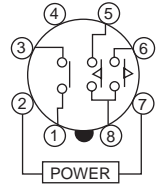



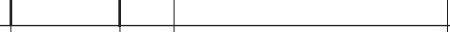

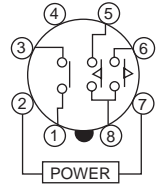



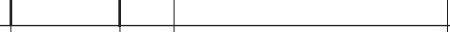

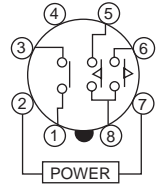



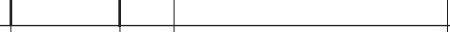

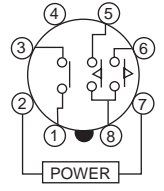
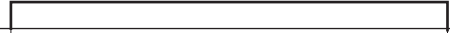





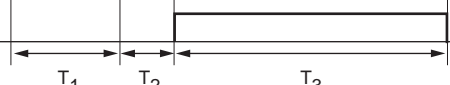
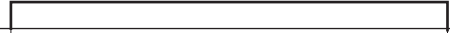

GT3S Table of Contents

- Specifications — G-42
- Operation Charts — G-43
- GT3 Accessories — G-48
- GT3 Instructions — G-50
- GT3 Dimensions — G-52
- Timing Diagrams Overview — G-4

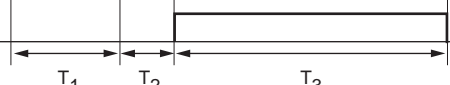
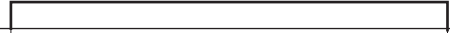
General Specifications

Operation System	Solid state CMOS circuitry	
Operation Type	Star-delta	
Time Range	Star side: 0.05 to 100 sec Star-delta switching time: 0.05, 0.1, 0.25, 0.5 sec	
Rated Operational Voltage	100 to 240V AC (50/60Hz)	
Operating Temperature	-10 to +50°C	
Storage Temperature	-30 to +80°C	
Operating Humidity	45 to 85% RH	
Voltage Tolerance	85 to 264V AC	
Repeat Error	±0.2%, ±10 msec	
Voltage Error	±0.2%, ±10 msec	
Temperature Error	±0.2%, ±10 msec	
Setting Error	±10% maximum	
Reset Time	500 msec maximum	
Insulation Resistance	100MΩ minimum	
Dielectric Strength	Between power and output terminals: 2,000V AC, 1 minute Between contacts of different poles: 2,000V AC, 1 minute Between contacts of the same pole: 750V AC, 1 minute	
Vibration Resistance	100 m/sec ² (Approx. 10G)	
Shock Resistance	Operating extremes: 100m/sec ² (Approx. 10G) Damage limits: 500m/sec ² (Approx. 50G)	
Power Consumption (Approx.)	Type GT3S-1	3.0VA (100V AC, 60Hz), 10.4VA (200V AC, 60Hz)
	Type GT3S-2	4.0VA (100V AC, 60Hz), 12.0VA (200V AC, 60Hz)

Operation Charts

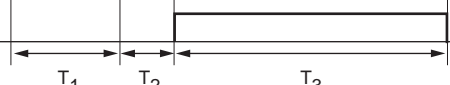
Product Series	Internal Connection & Terminal Arrangement	Operation Chart																							
GT3S-1 Star: Delayed SPST-NO Delta: Delayed SPST-NO	(8-pin Type)  5-8: Star contact 6-8: Delta contact	<table border="1"> <thead> <tr> <th>Item</th> <th>Terminal No.</th> <th>Operation</th> </tr> </thead> <tbody> <tr> <td>Power</td> <td>2-7 (8p) : (POWER)</td> <td></td> </tr> <tr> <td>Star Delayed Contact</td> <td>5-8 (8p) (NO)</td> <td></td> </tr> <tr> <td>Delta Delayed Contact</td> <td>6-8 (8p) (NO)</td> <td></td> </tr> <tr> <td rowspan="2">Indicator</td> <td>Star</td> <td></td> </tr> <tr> <td>Delta</td> <td></td> </tr> <tr> <td>Set Time</td> <td></td> <td></td> </tr> </tbody> </table> <p> •The star delayed contact goes on when power is turned on and goes off after a set time for the star contact (T_1). The delta delayed contact goes on after star-delta switching time (T_2) and goes off when power is turned off. T_1 = Star ON time (Set Time), T_2 = Star-delta switching time, T_3 = Delta ON time </p>	Item	Terminal No.	Operation	Power	2-7 (8p) : (POWER)		Star Delayed Contact	5-8 (8p) (NO)		Delta Delayed Contact	6-8 (8p) (NO)		Indicator	Star		Delta		Set Time					
Item	Terminal No.	Operation																							
Power	2-7 (8p) : (POWER)																								
Star Delayed Contact	5-8 (8p) (NO)																								
Delta Delayed Contact	6-8 (8p) (NO)																								
Indicator	Star																								
	Delta																								
Set Time																									
GT3S-2 Star: Delayed SPST-NO Delta: Delayed SPST-NO Instantaneous SPST-NO	(8-pin Type)  5-8: Star contact 6-8: Delta contact	<table border="1"> <thead> <tr> <th>Item</th> <th>Terminal No.</th> <th>Operation</th> </tr> </thead> <tbody> <tr> <td>Power</td> <td>2-7 (8p) (POWER)</td> <td></td> </tr> <tr> <td>Star Delayed Contact</td> <td>5-8 (8p) (NO)</td> <td></td> </tr> <tr> <td>Delta Delayed Contact</td> <td>6-8 (8p) (NO)</td> <td></td> </tr> <tr> <td>Instantaneous Contact</td> <td>1-3 (8p) (NO)</td> <td></td> </tr> <tr> <td rowspan="2">Indicator</td> <td>Star</td> <td></td> </tr> <tr> <td>Delta</td> <td></td> </tr> <tr> <td>Set Time</td> <td></td> <td></td> </tr> </tbody> </table> <p> •The star delayed contact goes on when power is turned on and goes off after a set time for the star contact (T_1). The delta delayed contact goes on after star-delta switching time (T_2) and goes off when power is turned off. •The instantaneous contact goes on when power is turned on and goes off when power is turned off. T_1 = Star ON time (Set Time), T_2 = Star-delta switching time, T_3 = Delta ON time </p>	Item	Terminal No.	Operation	Power	2-7 (8p) (POWER)		Star Delayed Contact	5-8 (8p) (NO)		Delta Delayed Contact	6-8 (8p) (NO)		Instantaneous Contact	1-3 (8p) (NO)		Indicator	Star		Delta		Set Time		
Item	Terminal No.	Operation																							
Power	2-7 (8p) (POWER)																								
Star Delayed Contact	5-8 (8p) (NO)																								
Delta Delayed Contact	6-8 (8p) (NO)																								
Instantaneous Contact	1-3 (8p) (NO)																								
Indicator	Star																								
	Delta																								
Set Time																									

GT3W Series — Dual Time Range Timers



Key features of the GT3W series include:

- Sequential start, sequential interval, on-delay, recycler, and interval ON timing functions
- 2 time settings in one timer
- 8 selectable operation modes on each model
- Mountable in sockets or flush panel
- Power and output status indicating LEDs
- Time ranges up to 300 hours



c-uL Listed
UL Listed
File No.E55996



Timers

General Specifications			
Operation System	Solid state CMOS Circuit		
Operation Type	Multi-Mode		
Time Range	1: 0.1sec to 6hours, 3: 0.1sec to 300hours		
Pollution Degree	2 (IE60664-1)		
Over voltage category	III (IE60664-1)		
Rated Operational Voltage	AF20 100-240V AC(50/60Hz)		
	AD24 24V AC(50/60Hz)/24V DC		
	D12 12V DC		
Voltage Tolerance	AF20 85-264V AC(50/60Hz)		
	AD24 20.4-26.4V AC(50/60Hz)/21.6-26.4V DC		
	D12 10.8-13.2V DC		
Disengaging value of Input Voltage	Rated Voltage x10% minimum		
Range of Ambient Operating Temperature	-10 to +50°C (without freezing)		
Range of Ambient Storage and Transport Temperature	-30 to +75°C (without freezing)		
Range of Relative Humidity	35 to 85%RH (without condensation)		
Atmospheric Pressure	80kPa to 110kPa (Operating), 70kPa to 110kPa (Transport)		
Reset Time	60msec maximum		
Repeat Error	±0.2%, ±10msec*		
Voltage Error	±0.2%, ±10msec*		
Temperature Error	±0.6%, ±10msec*		
Setting Error	±10% maximum		
Insulation Resistance	100MΩ minimum (500V DC)		
Dielectric Strength	Between power and output terminals: 2000V AC, 1 minute Between contacts of different poles: 2000V AC, 1 minute Between contacts of the same pole:750V AC, 1 minute		
Vibration Resistance	10 to 55Hz amplitude 0.75mm2 hours in each of 3 axes		
Shock Resistance	Operating extremes: 98m/sec ² (approx.10G) Damage limits: 490m/sec ² (approx. 50G) 3 times in each of 3 axes		
Degree of Protection	IP40 (enclosure), IP20 (socket) (IEC60529)		
Power Consumption (Approx.)	AF20	100V AC/60Hz	2.3VA
		200V AC/60Hz	4.6VA
	AD24 (AC/DC)	1.8VA/0.9W	
Mounting Position	Free		
Dimensions	40Hx 36W x 70 mm		
Weight (Approx.)	72g		

Contact Ratings		
Allowable Contact Power	960VA/120W	
Allowable Voltage	250V AC/150V DC	
Allowable Current	5A	
Maximum permissible operating frequency	1800 cycles per hour	
Rated Load	1/8HP, 240V AC	
	3A, 240V AC (Resistive)	
	5A, 120V AC/30V DC (Resistive)	
Conditional Short Circuit	Fuse 5A, 250V	
Life	Electrical	100,000 op. minimum (Resistive)
	Mechanical	20,000,000 op. minimum

GT3W Table of Contents

- Specifications — G-44
- Part Number List — G-45
- Timing Diagrams / Schematics — G-46
- Instructions: Setting Timer — G-47
- GT3 Accessories — G-48
- GT3 Instructions — G-50
- GT3 Dimensions — G-52
- Timing Diagrams Overview — G-4



** For the value of the error against a preset time, whichever the largest.

Part Number List

Part Numbers

Mode of Operation	Output	Contact	Time Range*	Rated Voltage	Pin Configuration	New Part Numbers	
A: Sequential Start B: On-delay with course & fine C: Recycler & instantaneous D: Recycler outputs (OFF Start) E: Recycler outputs (ON Start) F: Interval ON G: Interval ON Delay H: Sequential Interval	3A, 240V AC	Delayed SPDT + Delayed SPDT	1: 0.1sec - 6 hours *(See Time Range Settings for details.)	100 to 240V AC (50/60Hz)	8 pin	GT3W-A11AF20N	
					11 pin	GT3W-A11EAF20N	
				24V AC/DC	8 pin	GT3W-A11AD24N	
					11 pin	GT3W-A11EAD24N	
					12V DC	8 pin	GT3W-A11D12N
	11 pin	GT3W-A11ED12N					
	5A, 120V AC/30V DC (Resistive Load)			3: 0.1sec - 300 hours	100 to 240V AC (50/60Hz)	8 pin	GT3W-A33AF20N
					24V AC/DC		GT3W-A33AD24N



1. For schematics, see page G-46.
2. For socket and accessory part number information, see page G-48.
3. 8- and 11-pin models differ only in the number of pins (extra pins are not used).
4. For the timing diagram overview, see page G-4.
5. *For details on setting time ranges, see the instructions on page G-47.

Time Range Table

Time Range Code: 1			Time Range Code: 3		
Time Range Selector	Scale	Time Range	Time Range Selector	Scale	Time Range
1S	0-1	0.1 sec - 1 sec	1S	0 - 3	0.1 sec - 3 sec
10S		0.3 sec - 10 sec	1M		3 sec - 3 min
10M		15 sec - 10 min	1H		3 min - 3 hours
1S	0 - 6	0.1 sec - 6 sec	1S	0 - 30	0.6 sec - 30 sec
10S		1 sec - 60 sec	1M		36 sec - 30 min
1M		6 sec - 6 min	1H		36min - 30 hours
10M		1 min - 60 min	10H		6 hours - 300 hours
1H		6 min - 6 hours			

Timing Diagrams/Schematics

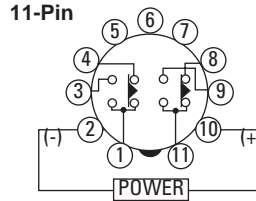
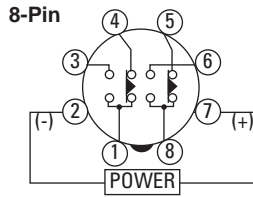

MODE	Operation chart			MODE	Operation chart		
A : Sequential Start	Item	Terminal No.	Operation	E : Recycler outputs (ON Start)	Item	Terminal No.	Operation
	Power	2-7(8p) 2-10(11p)	[Timing diagram showing power pulse]		Power	2-7(8p) 2-10(11p)	[Timing diagram showing power pulse]
B : On-delay with course and fine	Delayed Contact Ry1	1-4(8p) 1-4(11p) (NC) 1-3(8p) 1-3(11p) (NO)	[Timing diagram showing Ry1 contact state]	F : Interval ON	Delayed Contact Ry1	1-4(8p) 1-4(11p) (NC) 1-3(8p) 1-3(11p) (NO)	[Timing diagram showing Ry1 contact state]
	Delayed Contact Ry2	5-8(8p) 8-11(11p) (NC) 6-8(8p) 9-11(11p) (NO)	[Timing diagram showing Ry2 contact state]		Delayed Contact Ry2	5-8(8p) 8-11(11p) (NC) 6-8(8p) 9-11(11p) (NO)	[Timing diagram showing Ry2 contact state]
C : Recycler and instantaneous	Indicator	OUT1 OUT2	[Timing diagram showing indicator states]	G : Interval ON Delay	Indicator	OUT1 OUT2	[Timing diagram showing indicator states]
	Set Time		T1 T2		Set Time		T1 T2
D : Recycler outputs (OFF Start)	Delayed Contact Ry1	1-4(8p) 1-4(11p) (NC) 1-3(8p) 1-3(11p) (NO)	[Timing diagram showing Ry1 contact state]	H : Sequential Interval	Delayed Contact Ry1	1-4(8p) 1-4(11p) (NC) 1-3(8p) 1-3(11p) (NO)	[Timing diagram showing Ry1 contact state]
	Delayed Contact Ry2	5-8(8p) 8-11(11p) (NC) 6-8(8p) 9-11(11p) (NO)	[Timing diagram showing Ry2 contact state]		Delayed Contact Ry2	5-8(8p) 8-11(11p) (NC) 6-8(8p) 9-11(11p) (NO)	[Timing diagram showing Ry2 contact state]
	Indicator	OUT1 OUT2	[Timing diagram showing indicator states]		Indicator	OUT1 OUT2	[Timing diagram showing indicator states]
	Set Time		T1 T2 T1 T2		Set Time		T1 T2

Timers

Instructions: Setting GT3W Timer

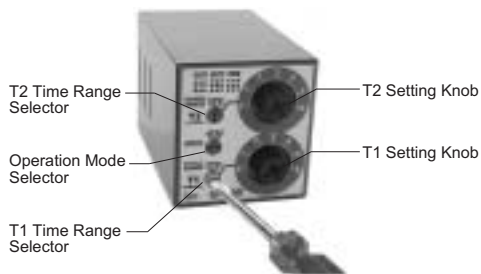

1. The switches should be securely turned using a flat screwdriver 4mm wide (maximum). Note that incorrect setting may cause malfunction. The switches, which do not turn infinitely, should not be turned beyond their limits.
2. Since changing the setting during timer operation may cause malfunction, turn power off before changing.

Safety Precautions

Special expertise is required to use Electronic Timers.

- All Electronic Timer modules are manufactured under IDEC's rigorous quality control system, but users must add a backup or fail safe provision to the control system when using the Electronic Timer in applications where heavy damage or personal injury may occur should the Electronic Timer fail.
- Install the Electronic Timer according to instructions described in this catalog.
- Make sure that the operating conditions are as described in the specifications. If you are uncertain about the specifications, contact IDEC in advance.
- In these directions, safety precautions are categorized in order of importance to Warning and Caution.

Warning

Warning notices are used to emphasize that improper operation may cause severe personal injury or death.

- Turn power off to the Electronic timer before starting installation, removal, Wiring, maintenance, and inspection on the Electronic Timer.
- Failure to turn power off may cause electrical shocks or fire hazard.
- Emergency stop and interlocking circuits must be configured outside the Electronic timer. If such a circuit is configured inside the Electronic Timer, failure of the Electronic timer may cause malfunction of the control system, or an accident.

Caution

Caution notices are used where inattention might cause personal injury or damage to equipment.

- The Electronic Timer is designed for installation in equipment. Do not install the Electronic Timer outside equipment.
- Install the Electronic Timer in environments described in the specifications. If the Electronic Timer is used in places where it will be subjected to high-temperature, high-humidity, condensation, corrosive gases, excessive vibrations, or excessive shocks, then electrical shocks, fire hazard, or malfunction could result.
- Use an IEC60127-approved fuse and circuit breaker on the power and output line outside the Electronic Timer.
- Do not disassemble, repair, or modify the Electronic Timer.
- When disposing of the Electronic Timer, do so as industrial waste.

Accessories: GT3 Series

DIN Rail Mounting Accessories

Part Numbers: DIN Rail/Surface Mount Sockets and Hold-Down Springs

DIN Rail Mount Socket				Applicable Hold-Down Springs	
Style	Appearance	Use with Timers	Part No.	Appearance	Part No.
8-Pin Screw Terminal (dual tier)		GT3A-1, 2, 3 (8-pin) GT3D-1, 2, 3 (8-pin) GT3F-1, 2 (8-pin) GT3W (8-pin) GT3S	SR2P-05		SFA-203
11-Pin Screw Terminal (dual tier)		GT3A-1, 2, 3 (11-pin) GT3A-4, 5, 6 GT3D-1, 2, 3 (11-pin) GT3D-4, 8 GT3F-1, 2 (11-pin) GT3W (11-pin)	SR3P-05		
8-Pin Fingersafe Socket		GT3A-1, 2, 3 (8-pin) GT3D-1, 2, 3 (8-pin) GT3F-1, 2 (8-pin) GT3W (8-pin) GT3S	SR2P-05C		
11-Pin Fingersafe Socket		GT3A-1, 2, 3 (11-pin) GT3A-4, 5, 6 GT3D-1, 2, 3 (11-pin) GT3D-4, 8 GT3F-1, 2 (11-pin) GT3W (11-pin)	SR3P-05C		SFA-202
8-Pin Screw Terminal		GT3A-1, 2, 3 (8-pin) GT3D-1, 2, 3 (8-pin) GT3F-1, 2 (8-pin) GT3W (8-pin) GT3S	SR2P-06		
11-Pin Screw Terminal		GT3A-1, 2, 3 (11-pin) GT3A-4, 5, 6 GT3D-1, 2, 3 (11-pin) GT3D-4, 8 GT3F-1, 2 (11-pin) GT3W (11-pin)	SR3P-06		
DIN Mounting Rail Length 1000mm		—	BNDN1000		

Installation of Hold-Down Springs

DIN Rail Mount Socket

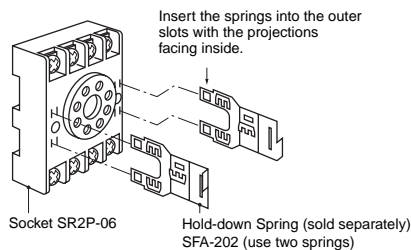

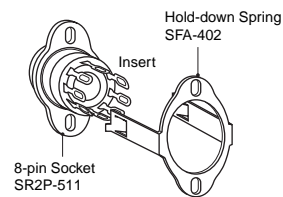

Panel Mount Socket



Panel Mounting Accessories





Part Numbers: Panel Mount Sockets and Hold-Down Springs

Panel Mount Socket				Applicable HD Springs	
Style	Appearance	Use with Timers	Part No.	Appearance	Part No.
8-Pin Solder Terminal		GT3A- (8-pin) GT3D- (8-pin) GT3W- (8-pin) GT3F- (8-pin) GT3S	SR2P-51		SFA-402
11-Pin Solder Terminal		GT3A- (11-pin) GT3D- (11-pin) GT3W- (11-pin) GT3F- (11-pin)	SR3P-51		



1. For information on installing the hold-down springs, see page G-48.

Part Numbers: Flush Panel Mount Adapter and Sockets that use an Adapter

Accessory	Description	Appearance	Use with Timers	Part No.
Panel Mount Adapter	Adaptor for flush panel mounting GT3 timers		All GT3 timers	RTB-G01
Sockets for use with Panel Mount Adapter	8-pin screw terminal	 (Shown: SR6P-M08G for Wiring Socket Adapter)	All 8-pin timers	SR6P-M08G
	11-pin screw terminal		All 11-pin timers	SR6P-M11G
	8-pin solder terminal		All 8-pin timers	SR6P-S08
	11-pin solder terminal		All 11-pin timers	SR6P-S11



2. No hold down springs are available for flush panel mounting.

Instructions: Wiring Inputs for GT3 Series

Inputs

To avoid electric shock, do not touch the input signal terminal during power voltage application.

When connecting the input signal terminals of two or more GT3A timers to the same contact or transistor, the input terminals of the same number should be connected. (Connect Terminals No.2 in common.)

Incorrect

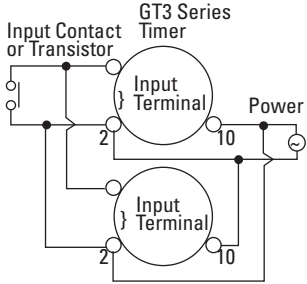

Correct

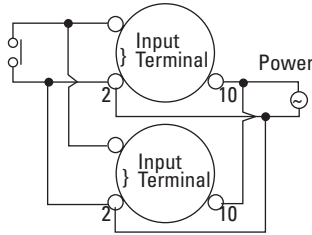

In a transistor circuit for controlling input signals, with its primary and secondary power circuits isolated, do not ground the secondary circuit.



Timers

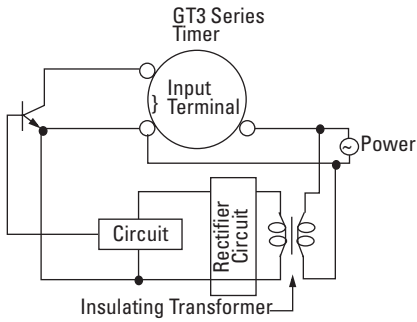

Connect the input signal terminals of the GT3A timers to Terminal No.2 only. Never apply voltage to other terminals; otherwise, the internal circuit may be damaged.

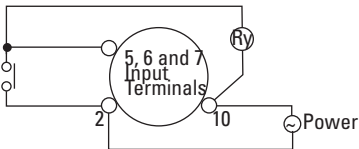

Input signal lines must be made as short as possible and installed away from power cables and power lines. Use shielded wires or a separate conduit for input wiring.

Inputs Instructions: continued

For contact input, use highly reliable gold-plated contacts to make sure that the residual voltage is less than 1V when the contacts are closed.

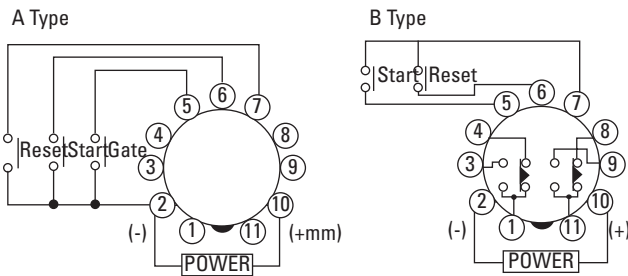

For transistor input, use transistors with the following specifications; $V_{CE} = 40V$, $V_{CES} = 1V$ or less, $I_C = 50\text{ mA}$ or more, and $I_{CBO} = 50\mu A$ or less. The resistance should be less than $1k\Omega$ when the transistor is on. When the output transistor switches on, a signal is input to the timer.

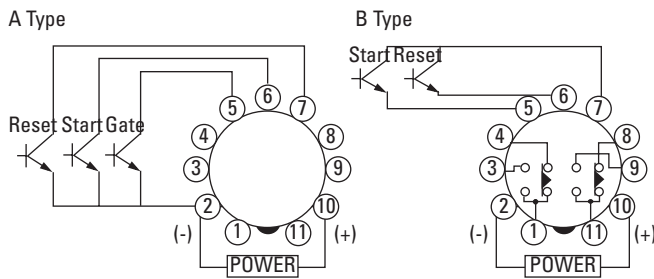

Inputs: GT3A-1, -2, -3

Transistor output equipment such as proximity switches and photoelectric switches can input signals if they are voltage/current output type, with power voltage ranges from 18 to 30V and have 1V. When the signal voltage switches from H to L, a signal is input to the timer.

Transistor Output Circuit

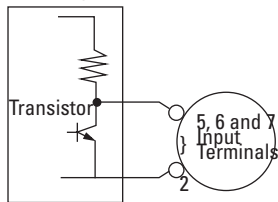

Inputs: GT3A-4, -5, -6

Start Input	The start input initiates a time-delay operation and controls output status.	No-voltage contact inputs and NPN open collector transistor inputs are applicable. 24V DC, 1mA maximum
Reset Input	When the reset input is activated, the time is reset, and contacts return to original state.	
Gate Input	The time-delay operation is suspended while the gate input is on (pause).	Input response time: 50msec maximum

Dimensions: GT3 Series

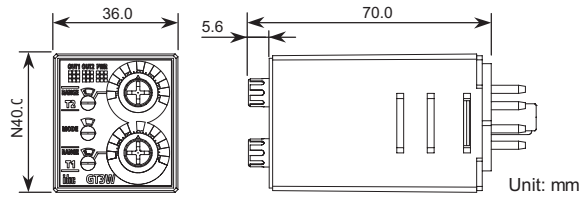

NOTE: GT3W series are UL Listed when used in combination with following IDEC's sockets:
 GT3W-A11, A33: SR2P-06* pin type socket.
 GT3W-A11E, A33: SR3P-05* pin type socket.
 (*-May be followed by A,B,C or U)
 The socket to be used with these timers are rated:
 -Conductor Temperature Rating 60°C min.
 -Use 14AWG max.(2mm²max.) Copper conductors only
 -Terminal Torque 1.0 to 1.3 N-m

Analog GT3 Timer, 8-Pin with SR2P-06

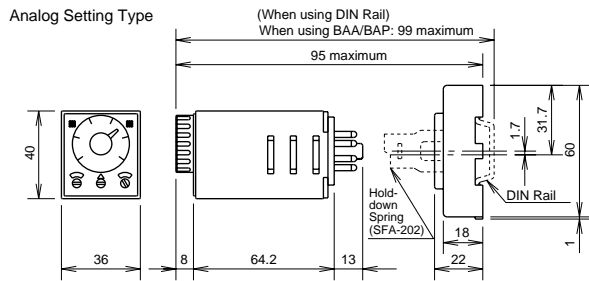

Analog GT3 Timer, 11-Pin with SR3P-06

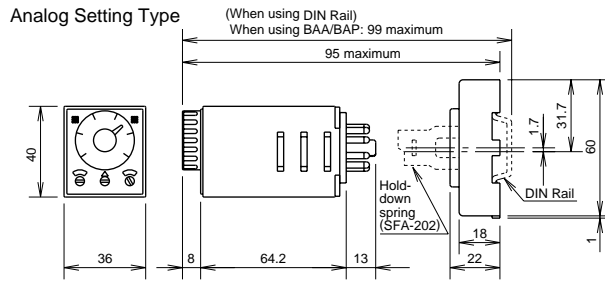

Digital GT3 Timer, 8-Pin with SR2P-06

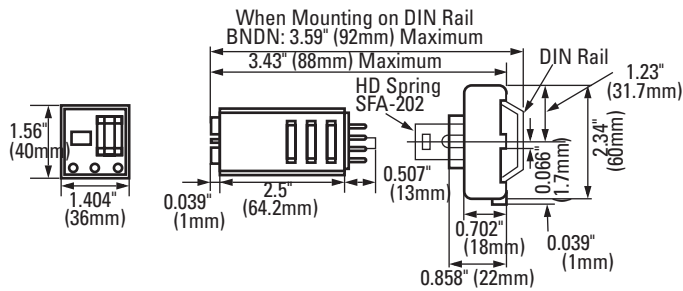

Digital GT3 Timer, 11-Pin with SR3P-06

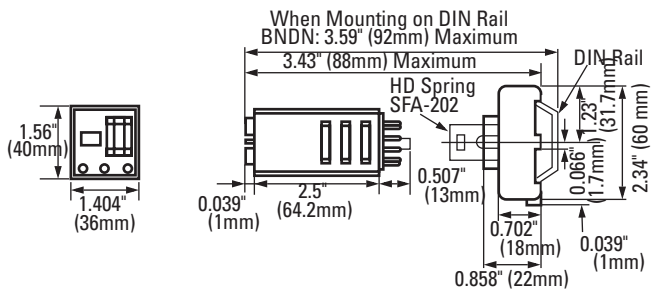

Analog GT3 Timer, 11-Pin with SR3P-05

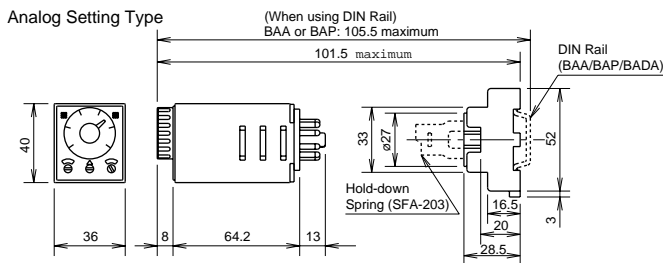

Digital GT3 Timer, 11-Pin with SR3P-05

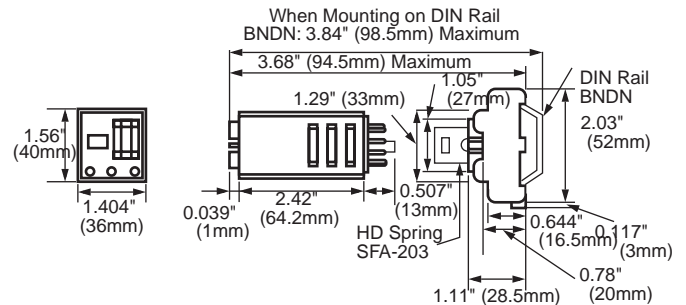

Timers

Panel Mount Adapter

Analog GT3 Timer, 8-Pin and 11-Pin with SR6P-S08 or SR6P-S11

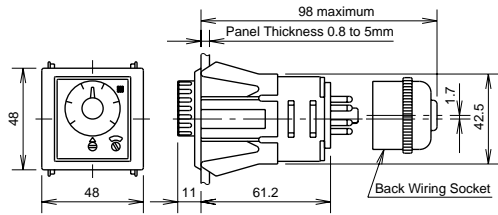

Digital GT3 Timer, 8-Pin and 11-Pin with SR6P-S08 or SR6P-S11

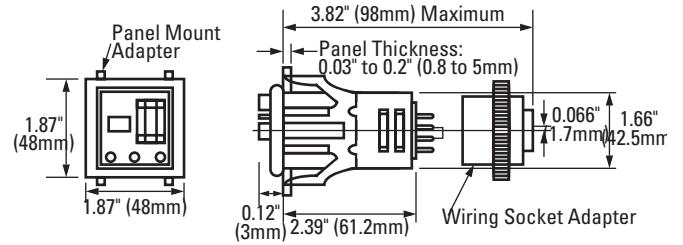

Mounting Hole Layout

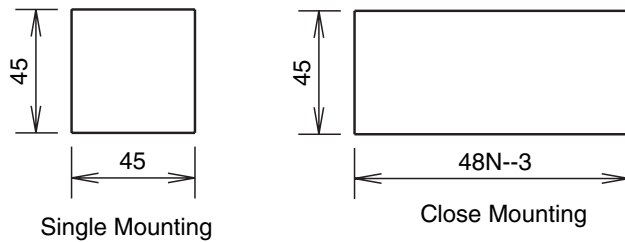

Analog and Digital GT3 Timer, 8-Pin with SR6P-M08G

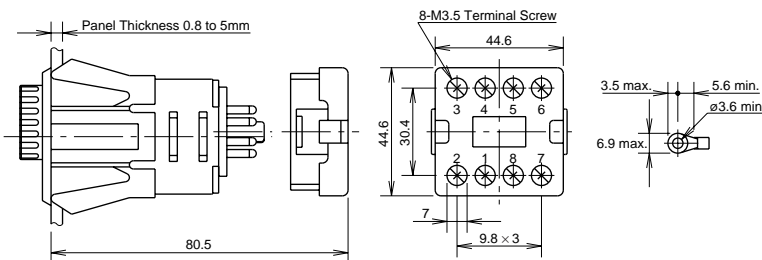

Analog and Digital GT3 Timer, 11-Pin with SR6P-M11G

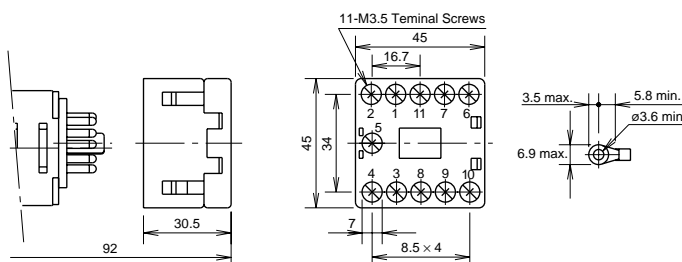

General Instructions for All Timer Series

Load Current

With inductive, capacitive, and incandescent lamp loads, inrush current more than 10 times the rated current may cause welded contacts and other undesired effects. The inrush current and steady-state current must be taken into consideration when specifying a timer.

Contact Protection

Switching an inductive load generates a counter-electromotive force (back EMF) in the coil. The back EMF will cause arcing, which may shorten the contact life and cause imperfect contact. Application of a protection circuit is recommended to safeguard the contacts.

Temperature and Humidity

Use the timer within the operating temperature and operating humidity ranges and prevent freezing or condensation. After the timer has been stored below its operating temperature, leave the timer at room temperature for a sufficient period of time to allow it to return to operating temperatures before use.

Environment

Avoid contact between the timer and sulfurous or ammonia gases, organic solvents (alcohol, benzene, thinner, etc.), strong alkaline substances, or strong acids. Do not use the timer in an environment where such substances are prevalent. Do not allow water to run or splash on the timer.

Vibration and Shock

Excessive vibration or shocks can cause the output contacts to bounce, the timer should be used only within the operating extremes for vibration and shock resistance. In applications with significant vibration or shock, use of hold down springs or clips is recommended to secure a timer to its socket.

Time Setting

The time range is calibrated at its maximum time scale; so it is desirable to use the timer at a setting as close to its maximum time scale as possible. For a more accurate time delay, adjust the control knob by measuring the operating time with a watch before application.

Input Contacts

Use mechanical contact switch or relay to supply power to the timer. When driving the timer with a solid-state output device (such as a two-wire proximity switch, photoelectric switch, or solid-state relay), malfunction may be caused by leakage current from the solid-state device. Since AC types comprise a capacitive load, the SSR dielectric strength should be two or more times the power voltage when switching the timer power using an SSR.

Generally, it is desirable to use mechanical contacts whenever possible to apply power to a timer or its signal inputs. When using solid state devices, be cautious of inrushes and back-EMF that may exceed the ratings on such devices. Some timers are specially designed so that signal inputs switch at a lower voltage than is used to power the timer (models designated as "B" type).

Timing Accuracy Formulas

Timing accuracies are calculated from the following formulas:

$$\text{Repeat Error} = \pm \frac{1}{2} \times \frac{\text{Maximum Measured Value} - \text{Minimum Measured Value}}{\text{Maximum Scale Value}} \times 100\%$$

$$\text{Voltage Error} = \pm \frac{T_v - T_r}{T_r} \times 100\%$$

T_v : Average of measured values at voltage V
 T_r : Average of measured values at the rated voltage

$$\text{Temperature Error} = \pm \frac{T_t - T_{20}}{T_{20}} \times 100\%$$

T_t : Average of measured values at °C
 T_{20} : Average of measured values at 20°C

$$\text{Setting Error} = \pm \frac{\text{Average of Measured Values} - \text{Set Value}}{\text{Maximum Scale Value}} \times 100\%$$