

GT5P Series — ON Delay Timers



Key features of the GT5P series include:

- SPDT, 5A contacts
- 8-pin, octal base
- 9 time ranges
- Repeat error $\pm 0.2\%$ maximum
- Control settings by hand or screwdriver
- Power ON and timing out LED indicators
- Uses the same sockets and hold down clips as IDEC's RR2P 8-pin relays



UL Recognized
File No. E55996



CSA Certified
File No. LR66809



Timers

Specifications

Rated Operating Voltage		100 to 120V AC (50/60Hz) 200 to 240V AC (50/60Hz) 24V AC/DC 12V DC
Voltage Tolerance		AC type: $\pm 15\%$ DC type: $\pm 10\%$ (ripple 10% maximum)
Contact Rating	Resistive load	120V AC/24V DC, 5A 240V AC, 3A
	Inductive load	240V AC, 0.8A 120V AC, 1.4A 24V DC, 1.7A
Allowable Contact Power (resistive load)		960VA AC 120W DC
Contact Form		SPDT
Voltage		250V AC, 150V DC
Repeat Error		$\pm 0.2\% \pm 10\text{msec}$
Voltage Error		$\pm 0.5\% \pm 10\text{msec}$
Temperature Error		$\pm 3\%$ maximum (over -10 to 50°C , reference temperature 20°C)
Setting Error		$\pm 10\%$ maximum
Reset Time		When turning power off <u>after</u> time up: 0.1 sec maximum When turning power off <u>before</u> time up: 1 sec maximum
Insulation Resistance		100M Ω minimum
Dielectric Strength		2000V AC, 1 minute (except between contacts of the same pole)
Vibration Resistance		100N (approximate 10G)
Shock Resistance		Operating extremes: 100N (approximate 10G) Damage limits: 500N (approximate 50G)
Power Consumption		100V AC type: 1.5VA (at 50Hz) 200V AC type: 1.6VA (at 50Hz) 24V DC type: 0.9W
Electrical Life		100,000 operations minimum (at rated load)
Mechanical Life		20,000,000 operations minimum
Operating Temperature		-10 to $+50^\circ\text{C}$
Operating Humidity		45 to 85% RH

GT5P Table of Contents

- Specifications — G-58
- Part Numbering List — G-59
- Timing Diagrams / Schematics — G-60
- GT5P Accessories — G-61
- GT5P Dimensions — G-62
- Timing Diagrams Overview — G-4



1. Inductive load (reference), $\cos\theta = .3$ to $.4$ or $L/R=15\text{msec}$.
2. Minimum applicable load: 5VDC/10mA (reference).

Part Numbering List

Mode of Operation	Contact	Output	Rated Voltage	Time Range	Complete Part No.
ON-Delay	SPDT	24V DC/ 120V AC, 5A 240V AC, 3A	100 to 120V AC	1S	—
				3S	GT5P-N3SA100
				6S	—
				10S	GT5P-N10SA100
				30S	GT5P-N30SA100
				60S	GT5P-N60SA100
				3M	GT5P-N3MA100
				6M	GT5P-N6MA100
				10M	GT5P-N10MA100
				200 to 240V AC	1S
			3S		—
			6S		GT5P-N6SA200
			10S		GT5P-N10SA200
			30S		GT5P-N30SA200
			60S		GT5P-N60SA200
			3M		GT5P-N3MA200
			6M		GT5P-N6MA200
			10M		GT5P-N10MA200
			24V AC/DC		1S
				3S	—
				6S	GT5P-N6SAD24
				10S	GT5P-N10SAD24
				30S	—
				60S	GT5P-N60SAD24
				3M	—
				6M	GT5P-N6MAD24
				10M	GT5P-N10MAD24
				12V DC	1S
			3S		—
			6S		—
			10S		GT5P-N10SD12
			30S		GT5P-N30SD12
			60S		GT5P-N60SD12
			3M		—
			6M		—
			10M		GT5P-N10MD12



G
Timers



For sockets and accessories, see page G-61.

Timing Diagram/Schematic/Electrical Life Curves

SPDT

Operation Mode

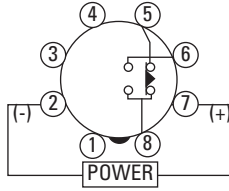

Do not apply voltage to terminals 1, 3, and 4.

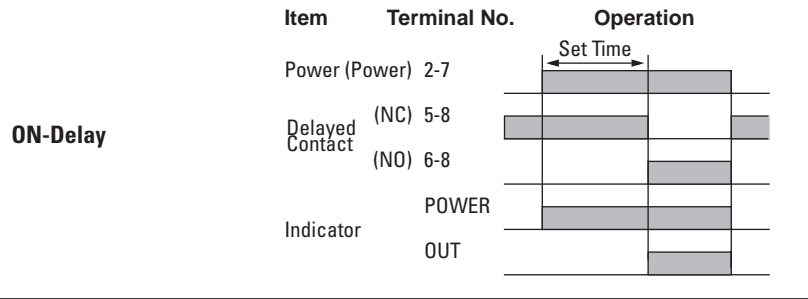

Electrical Life Curves

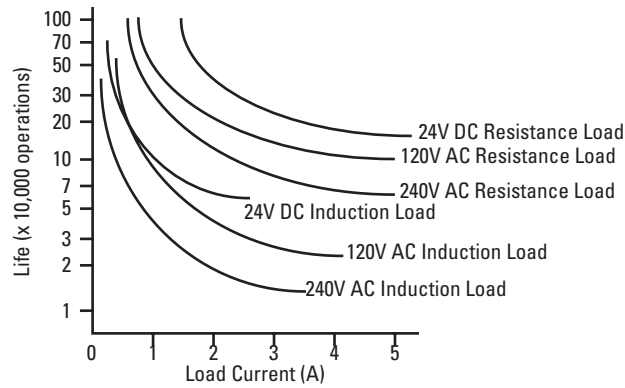

Timers

Mounting Accessories

Part Numbers: Mounting Accessories and Sockets					Applicable Hold-Down Springs	
Style	Appearance	Use with Timers	Part No.	Appearance	Part No.	
DIN Rail/ Surface Mounting Accessories	8-Pin Screw Terminal (dual tier)		GT5P	SR2P-05		SFA-203
	8-Pin Fingersafe Socket		GT5P	SR2P-05C		
	8-Pin Screw Terminal		GT5P	SR2P-06		SFA-202
	DIN Mounting Rail Length 1000mm		—	BNDN1000		
Part Numbers: Mounting Accessories and Sockets					Applicable Hold-Down Springs	
Mounting Accessories	8-Pin Solder Terminal			SR2P-51		SFA-402

Installation of Hold-Down Springs

DIN Rail Mount Socket

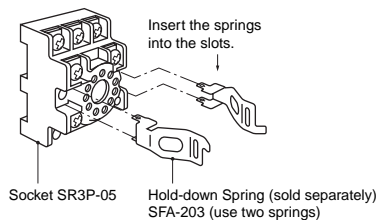
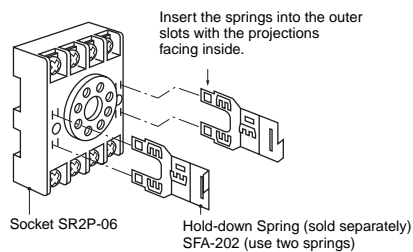

Panel Mount Socket

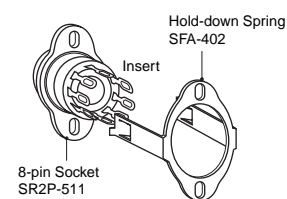

Dimensions: GT5P Series

GT5P Timer, 8-Pin with SR2P-05

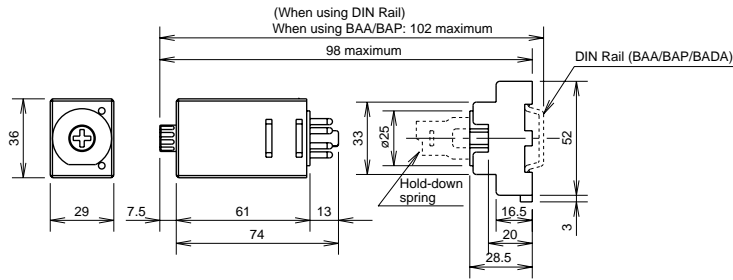

GT5P Timer, 8-Pin with SR2P-06

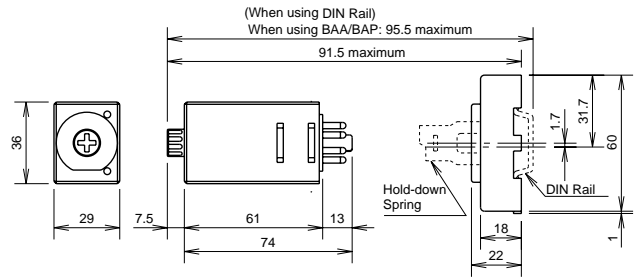

GT5Y Series — ON Delay Timers



Key features of the GT5Y series include:

- 4PDT, 3A or DPDT, 5A contacts
- 4 time ranges
- Repeat error $\pm 0.2\%$ maximum
- Control settings by hand or screwdriver
- Power ON and timing out LED indicators
- Uses the same sockets and hold-down clips as IDEC's RY4S and RU series relays



UL, c-uL Listed
File No. E55996



		GT5Y-2	GT5Y-4
Rated Operating Voltage		100 to 120V AC (50/60Hz) 200 to 240V AC (50/60Hz) 24V DC 24V AC 12V DC	
Contact Form		DPDT	4PDT
Rated Load	Resistive Load	220V AC, 5A 30V DC, 5A	220V AC, 3A 30V DC, 3A
	Inductive Load	220V AC, 2A 30V DC, 2.5A	220V AC, 0.8A 30V DC, 1.5A
Allowable Contact Power	Resistive Load	1100VA AC 150W DC	660VA AC 90W DC
	Inductive Load Cos $\theta = 0.3$ L/r = 7msec	440VA AC 75W DC	176VA AC 45W DC
Allowable Voltage		250V AC, 125V DC	
Allowable Current		5A	3A
Temperature Error		$\pm 3\%$ maximum (over -10 to 50°C , reference temperature 20°C)	
Setting Error		$\pm 10\%$ maximum	
Reset Time		When turning power off after time up: 0.1 second maximum When turning power off before time up: 1 second maximum	
Insulation Resistance		100M Ω minimum	
Dielectric Strength		2,000V AC, 1 minute (except between contacts of the same pole)	
Vibration Resistance		100N (approximate 10G)	
Shock Resistance		Operating extremes: 100N (approximate 10G) Damage limits: 500N (approximate 50G)	
Power Consumption		100V AC type: 1.5VA (at 50Hz) 200V AC type: 1.6VA (at 50Hz) 24V DC type: 0.9W	
Electrical Life		500,000 operations minimum (220V AC, 5A)	200,000 operations minimum (110V AC, 3A)
Mechanical Life		50,000,000 operations minimum	
Operating Temperature		-10 to $+50^\circ\text{C}$	
Operating Humidity		45 to 85% RH	

Specifications

G
Timers

GT5Y Table of Contents

- Part Number List — G-64
- Timing Diagrams — G-65
- GT5Y Accessories — G-66
- GT5Y Dimensions — G-67



1. Minimum applicable load: GT5Y-2: 5V DC, 20mA (reference value); GT5Y-4: 5V DC, 10mA (reference value).
2. Inductive load: $\cos \theta = .3$, L/R=7msec.

Part Numbering List

Mode of Operation	Contact	Output	Rated Voltage	Time Range	Complete Part No.
ON-Delay	DPDT	220V AC/ 30V DC, 5A	100 to 120V AC	1S/10S/1M/10M	GT5Y-2SN1A100
				3S/30S/3M/30M	GT5Y-2SN3A100
				6S/60S/6M/60M	GT5Y-2SN6A100
			200 to 240V AC	1S/10S/1M/10M	GT5Y-2SN1A200
				3S/30S/3M/30M	GT5Y-2SN3A200
				6S/60S/6M/60M	GT5Y-2SN6A200
			12V DC	1S/10S/1M/10M	GT5Y-2SN1D12
				3S/30S/3M/30M	GT5Y-2SN3D12
				6S/60S/6M/60M	GT5Y-2SN6D12
			24V DC	1S/10S/1M/10M	GT5Y-2SN1D24
				3S/30S/3M/30M	GT5Y-2SN3D24
				6S/60S/6M/60M	GT5Y-2SN6D24
	24V AC	1S/10S/1M/10M	GT5Y-2SN1A24		
		3S/30S/3M/30M	GT5Y-2SN3A24		
		6S/60S/6M/60M	GT5Y-2SN6A24		
	4PDT	220V AC/ 30V DC, 3A	100 to 120V AC	1S/10S/1M/10M	GT5Y-4SN1A100
				3S/30S/3M/30M	GT5Y-4SN3A100
				6S/60S/6M/60M	GT5Y-4SN6A100
			200 to 240V AC	1S/10S/1M/10M	GT5Y-4SN1A200
				3S/30S/3M/30M	GT5Y-4SN3A200
				6S/60S/6M/60M	GT5Y-4SN6A200
			12V DC	1S/10S/1M/10M	—
				3S/30S/3M/30M	GT5Y-4SN3D12
				6S/60S/6M/60M	—
24V DC			1S/10S/1M/10M	GT5Y-4SN1D24	
			3S/30S/3M/30M	GT5Y-4SN3D24	
			6S/60S/6M/60M	GT5Y-4SN6D24	
24V AC	1S/10S/1M/10M	GT5Y-4SN1A24			
	3S/30S/3M/30M	GT5Y-4SN3A24			
	6S/60S/6M/60M	GT5Y-4SN6A24			



Timers

 1. For sockets and accessories, see page G-66.

Timing Ranges

Code	Scale	Time Range Indication		Time Range
1S	0 to 10	x 0.1	S	0.1 second to 1 second
10S		x 1	S	0.2 second to 10 seconds
1M		x 0.1	M	1.2 seconds to 1 minute
10M		x 1	M	12 seconds to 10 minutes
3S	0 to 3	x 1	S	0.1 second to 3 seconds
30S		x 10	S	0.5 second to 30 seconds
3M		x 1	M	3 seconds to 3 minutes
30M		x 10	M	30 seconds to 30 minutes
6S	0 to 6	x 1	S	0.1 second to 6 seconds
60S		x 10	S	1 second to 60 seconds
6M		x 1	M	6 seconds to 6 minutes
60M		x 10	M	1 minute to 60 minutes

Timing Diagram/Schematics/Electrical Life Curves

	GT5Y-2	GT5Y-4																
Internal Connections (bottom view)																		
Operation Mode: ON-Delay	<table border="1" style="width: 100%; border-collapse: collapse;"> <thead> <tr> <th style="width: 15%;">Item</th> <th style="width: 20%;">Terminal No.</th> <th style="width: 65%;">Operation</th> </tr> </thead> <tbody> <tr> <td>Power (Power)</td> <td>13-14</td> <td style="text-align: center;"> </td> </tr> <tr> <td rowspan="2">Delayed Contact</td> <td>(NC) 1-9, 2-10, 3-11, 4-12</td> <td style="text-align: center;"> </td> </tr> <tr> <td>(NO) 5-9, 6-10, 7-11, 8-12</td> <td style="text-align: center;"> </td> </tr> <tr> <td rowspan="2">Indicator</td> <td>POWER</td> <td style="text-align: center;"> </td> </tr> <tr> <td>OUT</td> <td style="text-align: center;"> </td> </tr> </tbody> </table> <p style="text-align: center; margin-top: 10px;">For an explanation of timing modes, see page E-4.</p>		Item	Terminal No.	Operation	Power (Power)	13-14		Delayed Contact	(NC) 1-9, 2-10, 3-11, 4-12		(NO) 5-9, 6-10, 7-11, 8-12		Indicator	POWER		OUT	
Item	Terminal No.	Operation																
Power (Power)	13-14																	
Delayed Contact	(NC) 1-9, 2-10, 3-11, 4-12																	
	(NO) 5-9, 6-10, 7-11, 8-12																	
Indicator	POWER																	
	OUT																	

Electrical Life Curves

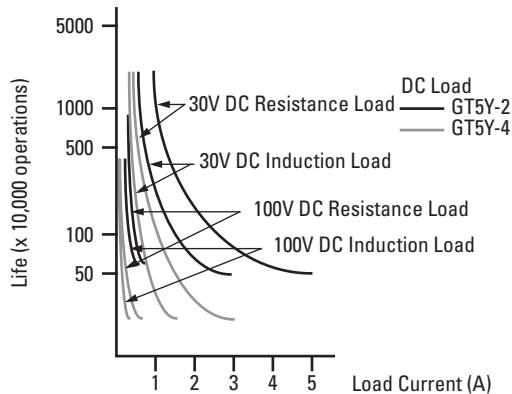
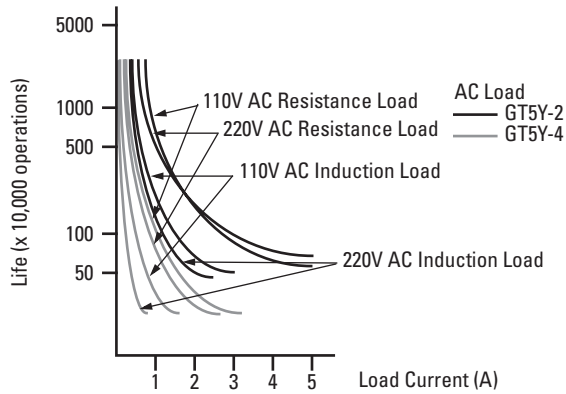





G
Timers

Accessories

DIN Rail Mounting Accessories

Part Numbers: DIN Rail/Surface Mount Sockets and Hold-Down Springs

DIN Rail Mount Socket			Applicable Hold-Down Springs	
Style	Appearance	Part No.	Appearance	Part No.
14-Blade Screw Terminal		SY4S-05		SFA-202
14-Blade Screw Terminal (fingersafe)		SY4S-05C		
DIN Mounting Rail Length 1000mm		BNDN1000		





Panel Mounting Accessories

Part Numbers: Panel Mount Socket and Hold-Down Springs

Panel Mount Socket			Applicable Hold-Down Springs	
Style	Appearance	Part No.	Appearance	Part No.
14-Blade Solder Terminal		SY4S-51		SFA-302

PCB Mounting Accessories

Part Numbers: PCB Mount Sockets with Applicable Hold-Down Springs

PCB Mount Socket			Applicable Hold-Down Springs	
Style	Appearance	Part No.	Appearance	Part No.
14 Blade, PCB Terminal		SY4S-61		SFA-302
14 Blade, PCB Terminal		SY4S-62		SY4S-02F1

Timers

Dimensions

GT5Y Timer, Blade with SY4S-05

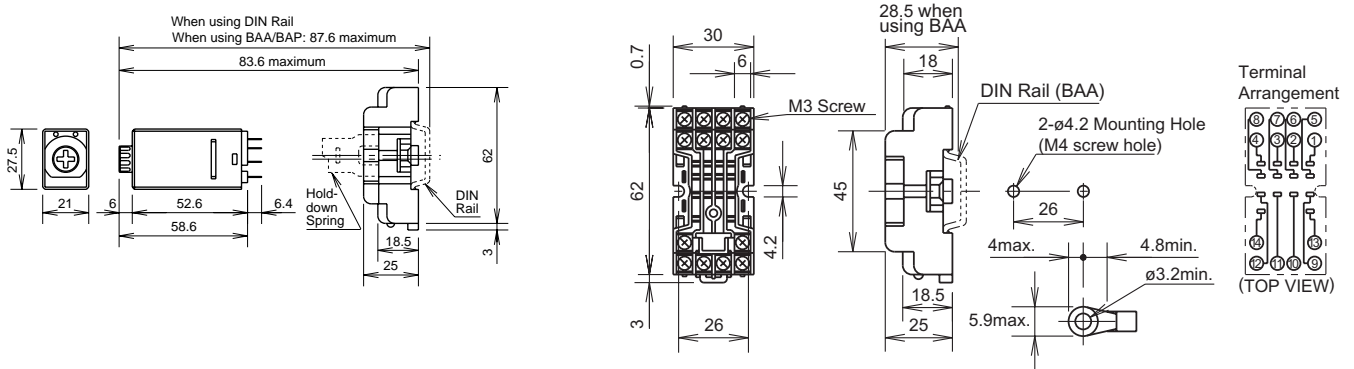

General Instructions for All Timer Series

Load Current

With inductive, capacitive, and incandescent lamp loads, inrush current more than 10 times the rated current may cause welded contacts and other undesired effects. The inrush current and steady-state current must be taken into consideration when specifying a timer.

Contact Protection

Switching an inductive load generates a counter-electromotive force (back EMF) in the coil. The back EMF will cause arcing, which may shorten the contact life and cause imperfect contact. Application of a protection circuit is recommended to safeguard the contacts.

Temperature and Humidity

Use the timer within the operating temperature and operating humidity ranges and prevent freezing or condensation. After the timer has been stored below its operating temperature, leave the timer at room temperature for a sufficient period of time to allow it to return to operating temperatures before use.

Environment

Avoid contact between the timer and sulfurous or ammonia gases, organic solvents (alcohol, benzene, thinner, etc.), strong alkaline substances, or strong acids. Do not use the timer in an environment where such substances are prevalent. Do not allow water to run or splash on the timer.

Vibration and Shock

Excessive vibration or shocks can cause the output contacts to bounce, the timer should be used only within the operating extremes for vibration and shock resistance. In applications with significant vibration or shock, use of hold down springs or clips is recommended to secure a timer to its socket.

Time Setting

The time range is calibrated at its maximum time scale; so it is desirable to use the timer at a setting as close to its maximum time scale as possible. For a more accurate time delay, adjust the control knob by measuring the operating time with a watch before application.

Input Contacts

Use mechanical contact switch or relay to supply power to the timer. When driving the timer with a solid-state output device (such as a two-wire proximity switch, photoelectric switch, or solid-state relay), malfunction may be caused by leakage current from the solid-state device. Since AC types comprise a capacitive load, the SSR dielectric strength should be two or more times the power voltage when switching the timer power using an SSR.

Generally, it is desirable to use mechanical contacts whenever possible to apply power to a timer or its signal inputs. When using solid state devices, be cautious of inrushes and back-EMF that may exceed the ratings on such devices. Some timers are specially designed so that signal inputs switch at a lower voltage than is used to power the timer (models designated as "B" type).

Timing Accuracy Formulas

Timing accuracies are calculated from the following formulas:

$$\text{Repeat Error} = \pm \frac{1}{2} \times \frac{\text{Maximum Measured Value} - \text{Minimum Measured Value}}{\text{Maximum Scale Value}} \times 100\%$$

$$\text{Voltage Error} = \pm \frac{T_v - T_r}{T_r} \times 100\%$$

T_v : Average of measured values at voltage V
 T_r : Average of measured values at the rated voltage

$$\text{Temperature Error} = \pm \frac{T_t - T_{20}}{T_{20}} \times 100\%$$

T_t : Average of measured values at °C
 T_{20} : Average of measured values at 20°C

$$\text{Setting Error} = \pm \frac{\text{Average of Measured Values} - \text{Set Value}}{\text{Maximum Scale Value}} \times 100\%$$